



BMW S 1000 RR
bis Baujahr 2011
Art.-Nr.: 670.600 schwarz

BMW S 1000 RR
ab Baujahr 2012
Art.-Nr.: 670.664 schwarz

BMW S 1000 RR
bis Baujahr 2011
Art.-Nr.: 4005.025.301 schwarz

BMW S 1000 RR
ab Baujahr 2012
Art.-Nr.: 4005.030.301 schwarz

Montage

Der Bausatz umfaßt die folgenden Teile:

| Stück | Bestellnr. | Bezeichnung |
|-------|------------|--|
| 1 | 700007451 | Gepäckplatte |
| 1 | 700007452 | Gummiträger |
| 1 | 700007453 | Rastwinkel |
| 2 | 151.331 | Senkschrauben M5 x 50 |
| 3 | 151.330 | Senkschrauben M5 x 25 |
| 2 | 151.274 | Senkschrauben M6 x 35 |
| 2 | 275001 | Gummipuffer Ø20 x 5,5mm |
| 2 | 150.799 | selbstsichernde Muttern M6 |
| 5 | 270.111 | selbstsichernde Muttern M5 |
| 4 | 151.283 | Verschlußstopfen Ø8 mm |
| 2 | 151.109 | Distanzhülsen Ø17 x Ø 7 x 6 mm |
| 2 | 151.319 | Distanzhülsen Ø10 x Ø 6 x 33 mm (Stahl verzinkt) |
| 1 | 150.728 | Distanzhülse Ø13 x Ø 7 x 7 mm |
| 2 | 150.821 | Distanzhülsen Ø18 x Ø 9 x 18 mm |
| 1 | | Dichtband 20x40 94 cm |
| 1 | 330.302 | Logo Hepco & Becker ø30mm |

**Das Originalschloss der Sozius-
sitzbank wird benötigt. Ein
Tauschen zwischen Sitzbank und
Sportrack ist somit nicht möglich.**

Modell bis 2011



Modell ab 2012

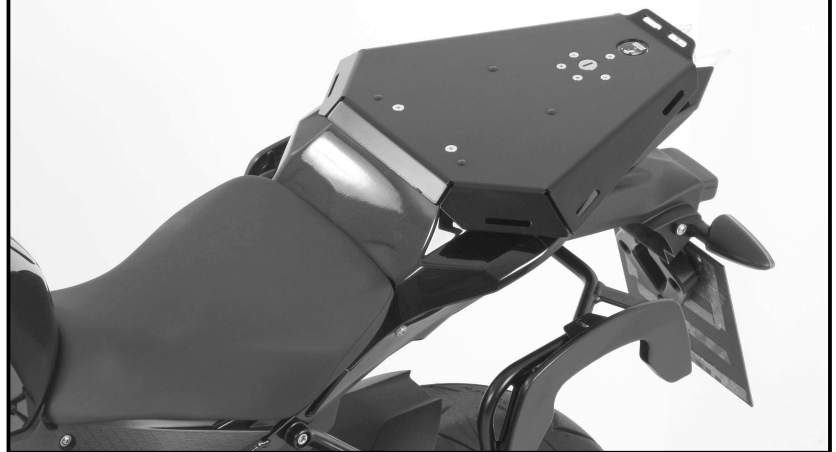

Anzugsmomente des Motorradherstellers beachten!
Nach der Montage alle Verschraubungen auf festen Sitz kontrollieren!
Bitte beachten Sie unsere beigefügten Serviceinformationen.



Hepco & Becker GmbH
An der Steinmauer 6
D-66955 Pirmasens
Tel.: 06331 - 1453 - 100
Fax: 06331 - 1453 - 120
eMail: vertrieb@hepco-becker.de
www.hepco-becker.de



Krauser GmbH
An der Steinmauer 6
D-66955 Pirmasens
Tel.: 06331 - 1453 - 250
Fax: 06331 - 1453 - 260
eMail: vertrieb@krauser.de
www.krauser.de



BMW S 1000 RR
bis Baujahr 2011
Art.-Nr.: 670.600 schwarz

BMW S 1000 RR
ab Baujahr 2012
Art.-Nr.: 670.664 schwarz

BMW S 1000 RR
bis Baujahr 2011
Art.-Nr.: 4005.025.301 schwarz

BMW S 1000 RR
ab Baujahr 2012
Art.-Nr.: 4005.030.301 schwarz

Montage

Vorbereitung:

Schloss mit Halteplatte von Original Soziussitzbank demontieren. Die Originalschrauben entfallen.

Die beiden Bohrungen in der Original - Riegelabdeckung (siehe **A**, Bild auf Seite 3) müssen auf mindestens 5mm aufgebohrt werden, damit die Schrauben M5 x 50 durchpassen.

Die 2 x Gummipuffer in den Gummiträger stecken.
Gummiträger fluchtend mit den Bohrungen auf die Gepäckplatte auflegen.

Montage des Rastwinkels vorne auf der Gepäckplatte:

Der Rastwinkel wird mit Distanzhülsen $\varnothing 18 \times \varnothing 9 \times 18\text{mm}$, den Senkschrauben M6 x 35 und selbstsichernden Muttern M6 auf der Gepäckplatte vorne verschraubt.

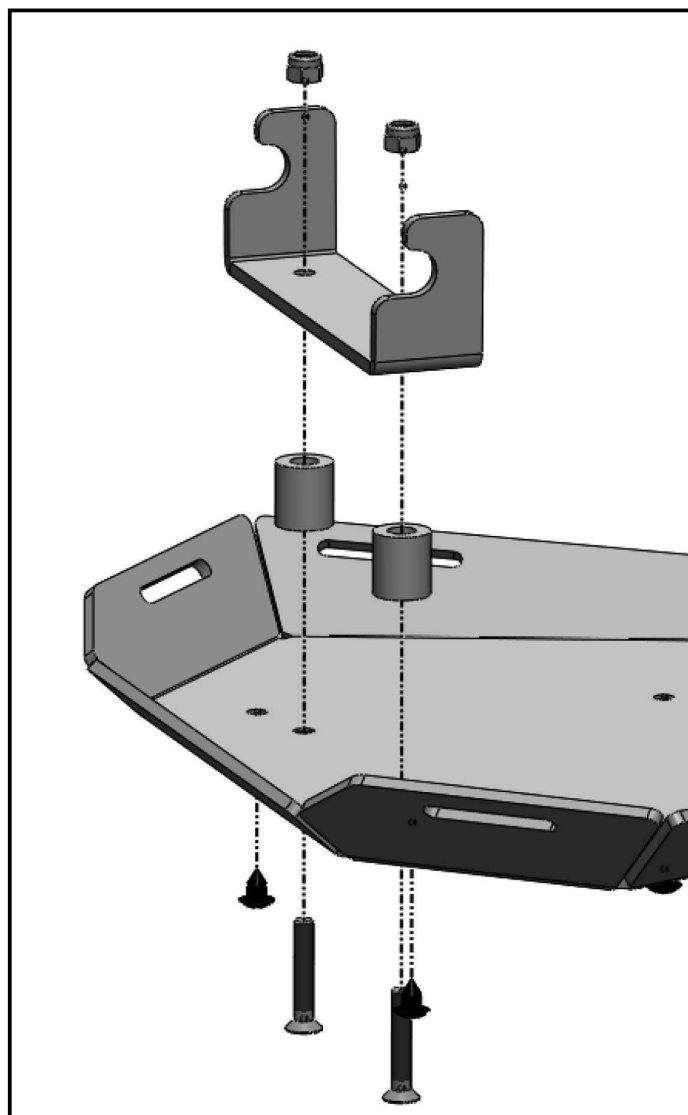
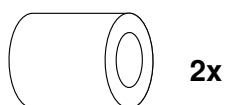
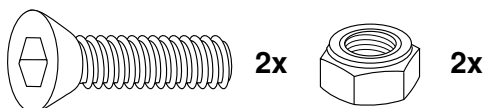



BMW S 1000 RR
bis Baujahr 2011
Art.-Nr.: 670.600 schwarz

BMW S 1000 RR
ab Baujahr 2012
Art.-Nr.: 670.664 schwarz

BMW S 1000 RR
bis Baujahr 2011
Art.-Nr.: 4005.025.301 schwarz

BMW S 1000 RR
ab Baujahr 2012
Art.-Nr.: 4005.030.301 schwarz

Montage

Montage des Schlosses hinten
auf der Gepäckplatte:

Das Original - Schloss mit Halteplatte ① wird vorne auf dem Gummiträger verschraubt.

② Vorne die Distanzhülsen $\text{Ø}17 \times \text{Ø}7 \times 6$ auflegen und mit den Senkschrauben M5 x 25 und selbstsichernden Mutter M5 verschrauben.

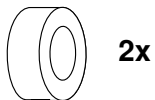

③ Mittig die Distanzhülsen $\text{Ø}10 \times \text{Ø}6 \times 33$ auflegen und mit den Senkschrauben M5 x 50 mit selbstsichernden Mutter M5 verschrauben.

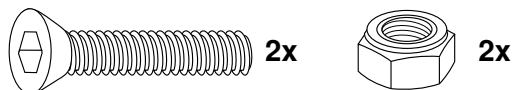

④ Hinten die Distanzhülse $\text{Ø}13 \times \text{Ø}7 \times 7\text{mm}$ auflegen und mit einer Senkschraube M5 x 25 und einer selbstsichernden Mutter M5 befestigen.

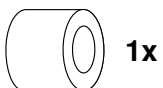
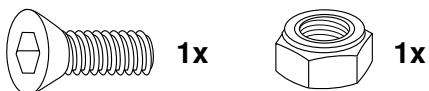

Die 4 nicht benutzten Bohrungen mit Verschlußstopfen verschließen.

Die Befestigung des SPORTRACKS am Motorrad erfolgt in der gleichen Weise wie beim Soziussitz.

Bitte vor dem Fahren den festen Sitz des SPORTRACKS im Schloss kontrollieren.

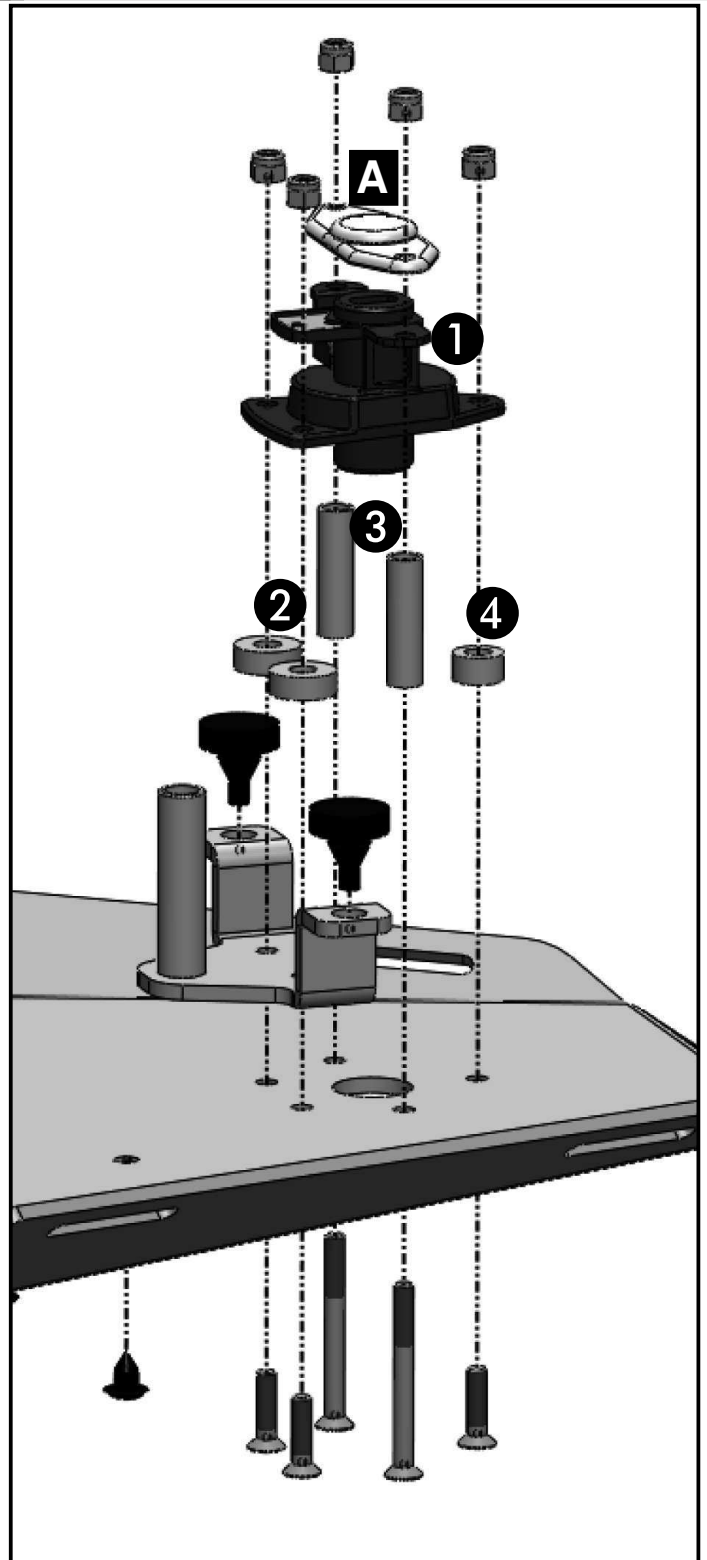



BMW S 1000 RR
bis Baujahr 2011
Art.-Nr.: 670.600 schwarz

BMW S 1000 RR
ab Baujahr 2012
Art.-Nr.: 670.664 schwarz

BMW S 1000 RR
bis Baujahr 2011
Art.-Nr.: 4005.025.301 schwarz

BMW S 1000 RR
ab Baujahr 2012
Art.-Nr.: 4005.030.301 schwarz

Montage

Anbringung des Dichtbandes:
dieses wird, wie gezeigt, auf der Rückseite der
Sportrackplatte aufgeklebt.

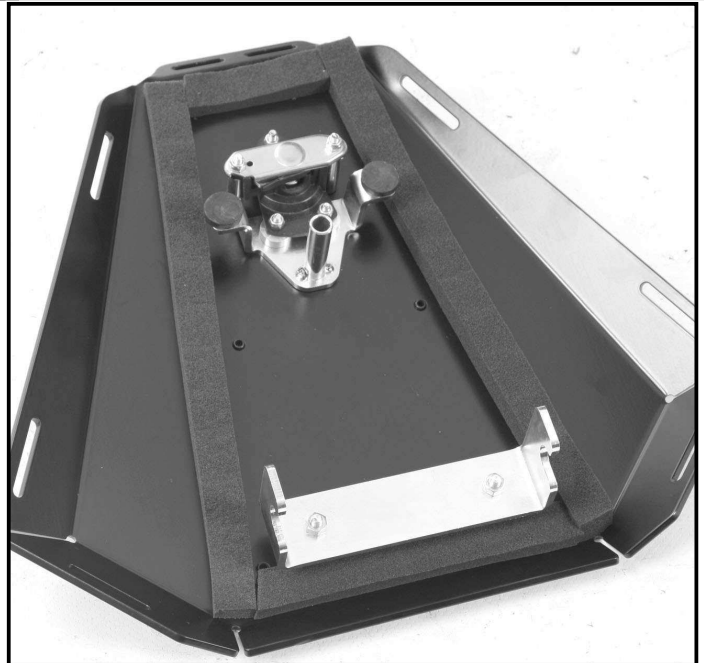



BMW S 1000 RR
up to date of manufacture 2011
Item-no: 670.600 black

BMW S 1000 RR
from date of manufacture 2012
Item-no: 670.664 black

BMW S 1000 RR
up to date of manufacture 2011
Item - No.: 4005.025.301 black

BMW S 1000 RR
from date of manufacture 2012
Item - No.: 4005.030.301 black

Assembling instructions

The kit includes the following parts:

| Quant | item no. | description |
|-------|-----------|----------------------------------|
| 1 | 700007451 | sportrack plate |
| 1 | 700007452 | rubber carrier |
| 1 | 700007453 | holding plate |
| 2 | 151.331 | countersunk head screw M5 x 50 |
| 3 | 151.330 | countersunk head screw M5 x 25 |
| 2 | 151.274 | countersunk head screw M6 x 35 |
| 2 | 275001 | rubber Ø20 x 5,5mm |
| 2 | 150.799 | self lock nuts M6 |
| 5 | 270.111 | self lock nuts M5 |
| 4 | 151.283 | plastic plug Ø8 mm |
| 2 | 151.109 | spacer Ø17 x Ø 7 x 6 mm |
| 2 | 151.319 | spacer Ø10 x Ø 6 x 33 mm (Steel) |
| 1 | 150.728 | spacer Ø13 x Ø 7 x 7 mm |
| 2 | 150.821 | spacer Ø18 x Ø 9 x 18 mm |
| 1 | | Seal strip 94 cm |
| 1 | 330.302 | emblem Hepco & Becker ø30mm |

The original lid of the pillion seat will be used. Therefore it is not possible to change the Sportrack with the Pillion seat again.

Model up to 2011



Model from 2012



**Control all screw connections after the assembling for tightness!
Please notice our enclosed service information.**



Hepco & Becker GmbH
An der Steinmauer 6
D-66955 Pirmasens
Tel.: +49 6331 - 1453 - 100
Fax: +49 6331 - 1453 - 120
eMail: vertrieb@hepco-becker.de
www.hepco-becker.de



Krauser GmbH
An der Steinmauer 6
D-66955 Pirmasens
Tel.: +49 6331 - 1453 - 250
Fax: +49 6331 - 1453 - 260
eMail: vertrieb@krauser.de
www.krauser.de



BMW S 1000 RR
up to date of manufacture 2011
Item-no: 670.600 black

BMW S 1000 RR
from date of manufacture 2012
Item-no: 670.664 black

BMW S 1000 RR
up to date of manufacture 2011
Item - No.: 4005.025.301 black

BMW S 1000 RR
from date of manufacture 2012
Item - No.: 4005.030.301 black

Assembling instructions

Preparing:

Dismantle pillion seat; dismantle the Original lid from the seat.

It is necessary, to bore the holes in the original lid cover to 5 mm diameter (refer to **A**, picture at page 3) to use the screws M5 x 50.

Mount rubbers to the rubber carrier.

Notice: to use both, the pillion seat or the Sportrack, another Original BMW lid is necessary. You can order this part from your BMW dealer.

Fastening of the holding plate at the front of the sportrack plate:

sandwich spacer $\text{Ø}18 \times \text{Ø}9 \times 18\text{mm}$.

Fix the holding plate with countersunk head screws M6 x 35 and self lock nuts M6.

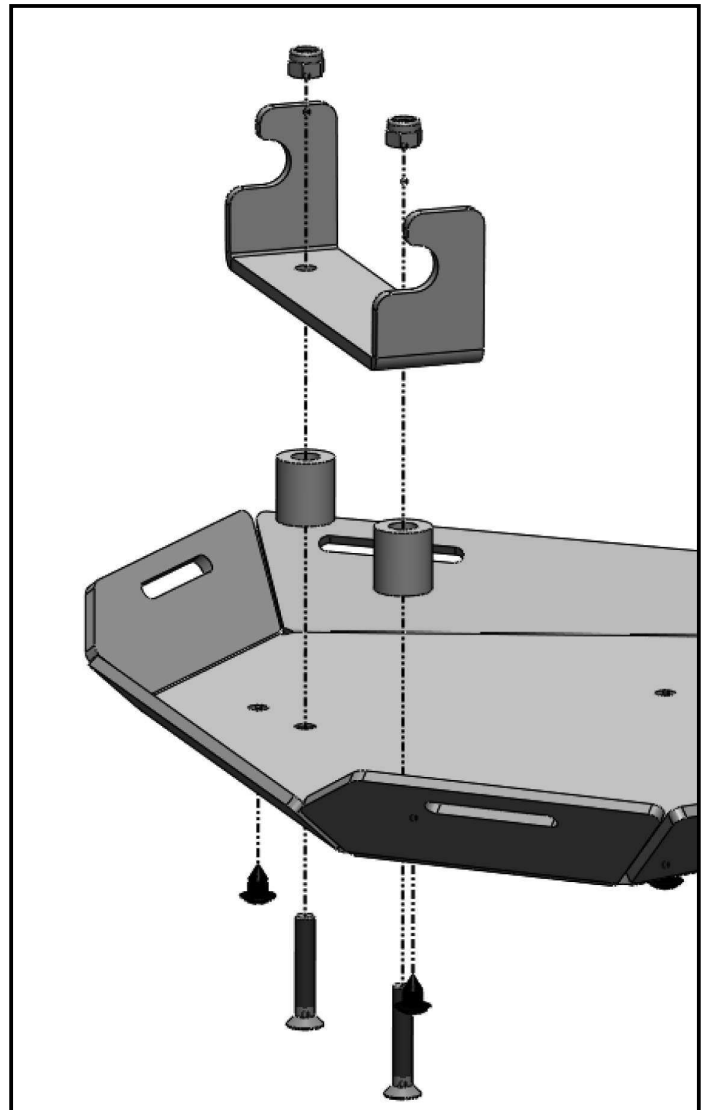
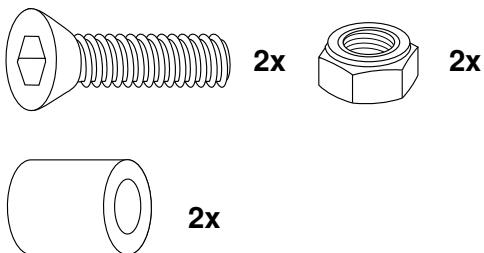



BMW S 1000 RR
up to date of manufacture 2011
Item-no: 670.600 black

BMW S 1000 RR
from date of manufacture 2012
Item-no: 670.664 black

BMW S 1000 RR
up to date of manufacture 2011
Item - No.: 4005.025.301 black

BMW S 1000 RR
from date of manufacture 2012
Item - No.: 4005.030.301 black

Assembling instructions

Fastening of the lid at the rear side of the sportrack plate:

Fix the original lid ① with holding plate at the rubber carrier.

② Front: sandwich spacer $\text{Ø}17 \times \text{Ø}7 \times 6\text{mm}$.
Fix the lid with countersunk head screws M5 x 25 and self lock nuts M5.

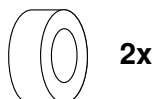

③ Middle: sandwich spacer $\text{Ø}10 \times \text{Ø}6 \times 33\text{mm}$.
Fix the lid with countersunk head screws M5 x 50 and self lock nuts M5.

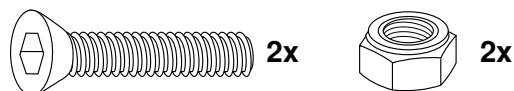

④ Rear: sandwich spacer $\text{Ø}13 \times \text{Ø}7 \times 7\text{mm}$.
Fix the lid with countersunk head screws M5 x 20 and self lock nuts M5.

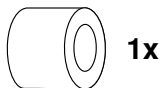
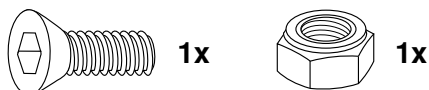

Put the plastic plugs into the free borings.

Before driving, control the correct and locked position of the SPORTRACK in the lid of the pillion seat !

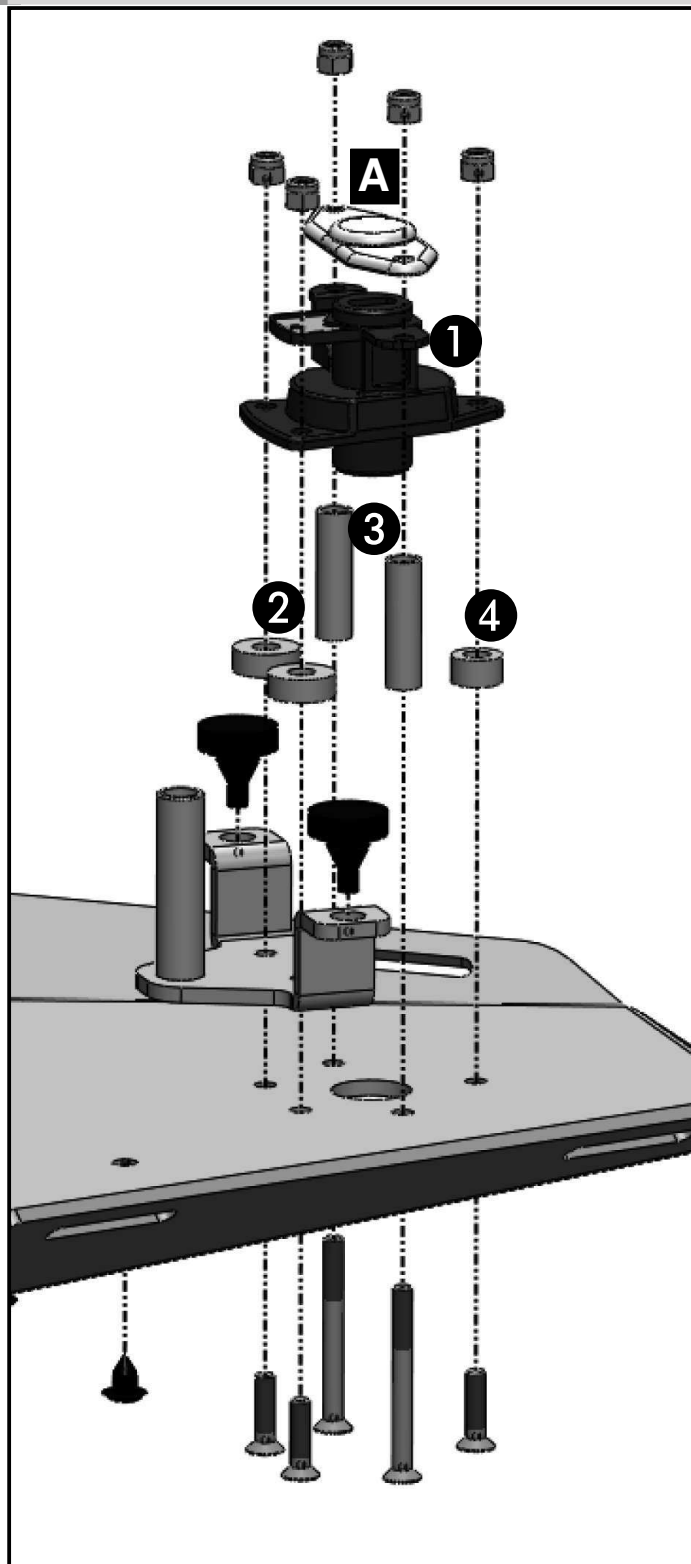



BMW S 1000 RR
up to date of manufacture 2011
Item-no: 670.600 black

BMW S 1000 RR
from date of manufacture 2012
Item-no: 670.664 black

BMW S 1000 RR
up to date of manufacture 2011
Item - No.: 4005.025.301 black

BMW S 1000 RR
from date of manufacture 2012
Item - No.: 4005.030.301 black

Assembling instructions

Affixing of the seal strip:
this will be stuck, as shown on the picture, to the back of the Sportrack plate.

