

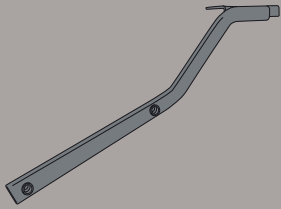

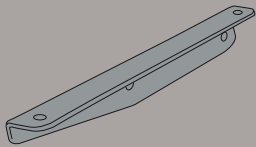









# 2132FZ - KZ2132

MONORACK SPECIFICO - SPECIFIC MONORACK - MONORACK SPECIFIQUE - SPEZIFISCHES MONORACK - MONORACK ESPECÍFICO - MONORACK ESPECÍFICA



## YAMAHA MT-09 (2017)

N°	Descrizione	Caratteristiche	Codice	Quantità	
1	Supporto - Support - Support Halterung - Soporte - Apoio	-	2115FZDXS 2115FZSXS	2 (Dx;Sx)	
2	Supporto - Support - Support Halterung - Soporte - Apoio	-	GL2544	2 (Dx;Sx)	
3	Vite - Screw Vis - Schraube Tornillo - Parafuso	TECF M8x30	830TECF	4	
4	Vite - Screw Vis - Schraube Tornillo - Parafuso	TCEI M8x25	825TCE	4	
5	Dado - Bolt - Ecrou Mutter - Tuerca - Porca	Auto Bloccante Flangiato M8	8DADIAFLN	4	
6	Coprivite - Screw Cap Cache Vis - Stopsschraube Tapa Tornillo - Boné Parafuso	Ø8	Z801	4	
7	Distanziale - Spacer Entretoise - Distanzstueck Distanciador - Espaçador	Ø18x12 Foro 8.5mm	C18L12F8,5T	4	
8	Particolari Inclusi Nel Kit Viteria Della Piastra Components Included In The Fitting Kit Of The Plate Pièces Incluses Dans Le Kit De Vis De La Platine Die Einzelnen Teile Sind Bei Montagekit Der Platte Enthalten Despieces Incluidos En El Kit De Anclajes De La Parrilla Explodiu Incluído No Kit As Âncoras Da Grelha	-	-	-	-
9	Supporto - Support - Support Halterung - Soporte - Apoio	-	GL1657V	1	
10	Anelli - Rings - Bagues - Anillos - Ringe - Anel	-	GL629V	2	
11	Connettore maschio - Male connector - Connecteur mâle - Conector macho - Stecker männlich - Plugue macho	-	Z2424	4	
12	Connettore femmina - Female connector - Connecteur femelle - Conector hembra - Stecker weiblich - Plugue fêmea	-	Z2425	4	
13	Prolunga - Extension cord - Rallonge électrique - Cable de extensión - Verlängerungskabel - Cabo de extensão	-	Z2426	2	
14	Vite - Screw Vis - Schraube Tornillo - Parafuso	TEN M6x12	612TEN	2	
15	Componenti Originali - Original Parts Parties Originales - Original Bauteile Componentes Originales - Componentes Originais	-	-	-	-

# 2132FZ - KZ2132

MONORACK SPECIFICO - SPECIFIC MONORACK - MONORACK SPECIFIQUE - SPEZIFISCHES MONORACK - MONORACK ESPECÍFICO - MONORACK ESPECÍFICA

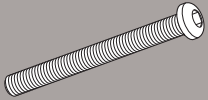
## YAMAHA MT-09 (2017)

16	Vite - Screw Vis - Schraube Tornillo - Parafuso	TBEI M6x50	650TBEI	2	
17	Rondella - Washer Rondelle - Scheibe Arandela - Arruela	-	Z1063	2	
18	Distanziale - Spacer Entretoise - Distanzstueck Distanciador - Espaçador	Ø15x30 Foro 6,5	C15L30F6,5T	2	

**ATTENZIONE: PESO MASSIMO CARICABILE 6Kg.**

**WARNING: MAX. LOADING 6Kg. (13lbs)**

**ATTENTION: CHARGE MAXIMALE 6Kg.**

**ACHTUNG: MAXIMALE BELASTUNG 6Kg.**

**¡ATENCIÓN!: CARGA MÁXIMA AUTORIZADA 6Kg.**

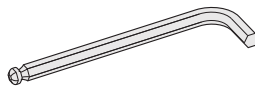
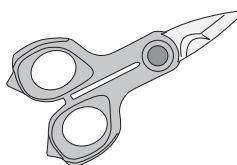
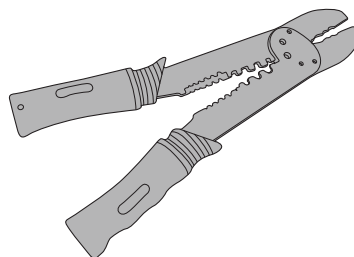
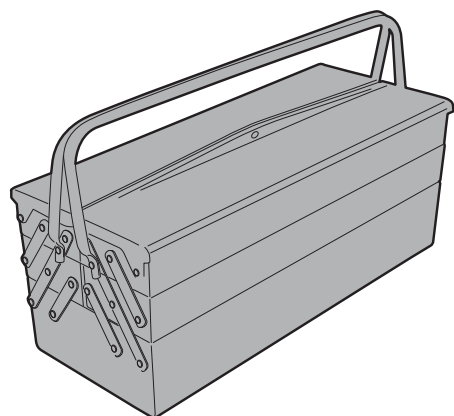

5mm - 6 mm

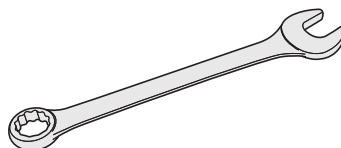

10mm - 12mm

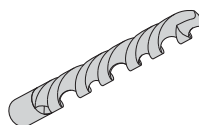

18 mm



# 2132FZ - KZ2132

MONORACK SPECIFICO - SPECIFIC MONORACK - MONORACK SPECIFIQUE - SPEZIFISCHES MONORACK - MONORACK ESPECÍFICO - MONORACK ESPECÍFICA

## YAMAHA MT-09 (2017)

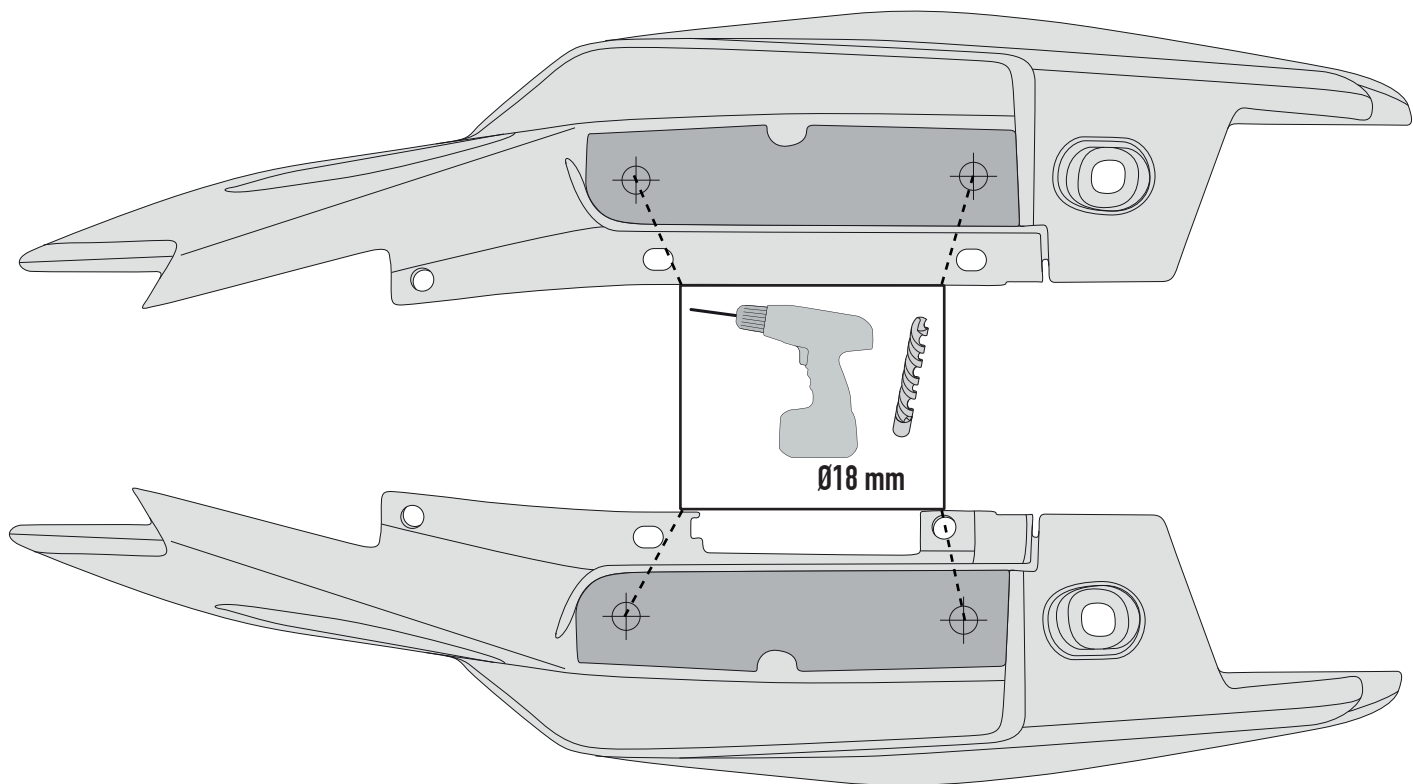
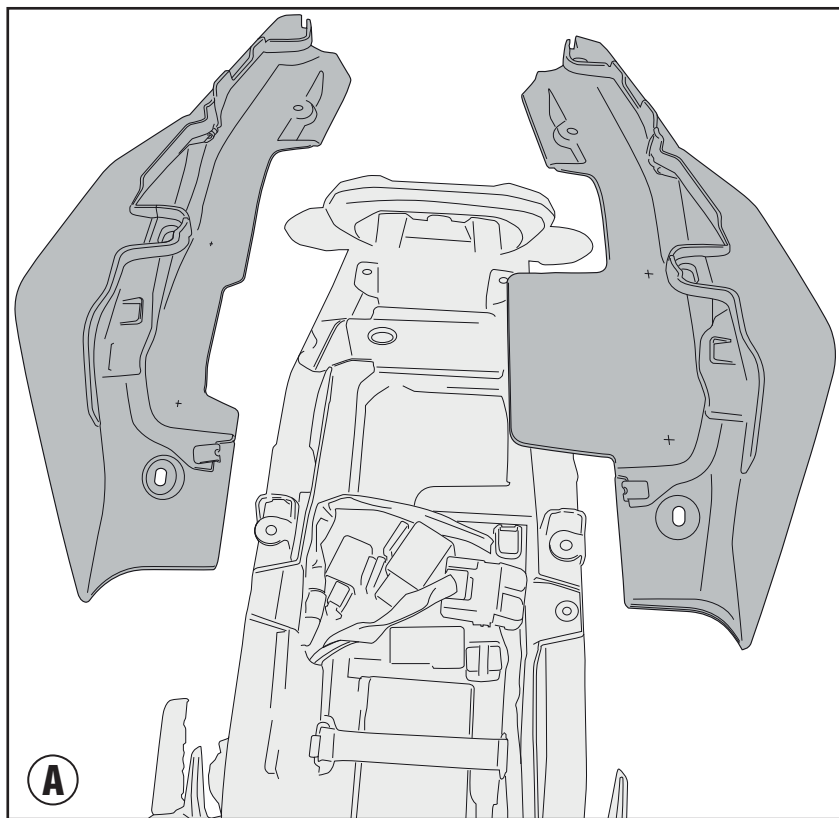

# 2132FZ - KZ2132

MONORACK SPECIFICO - SPECIFIC MONORACK - MONORACK SPECIFIQUE - SPEZIFISCHES MONORACK - MONORACK ESPECÍFICO - MONORACK ESPECÍFICA

## YAMAHA MT-09 (2017)

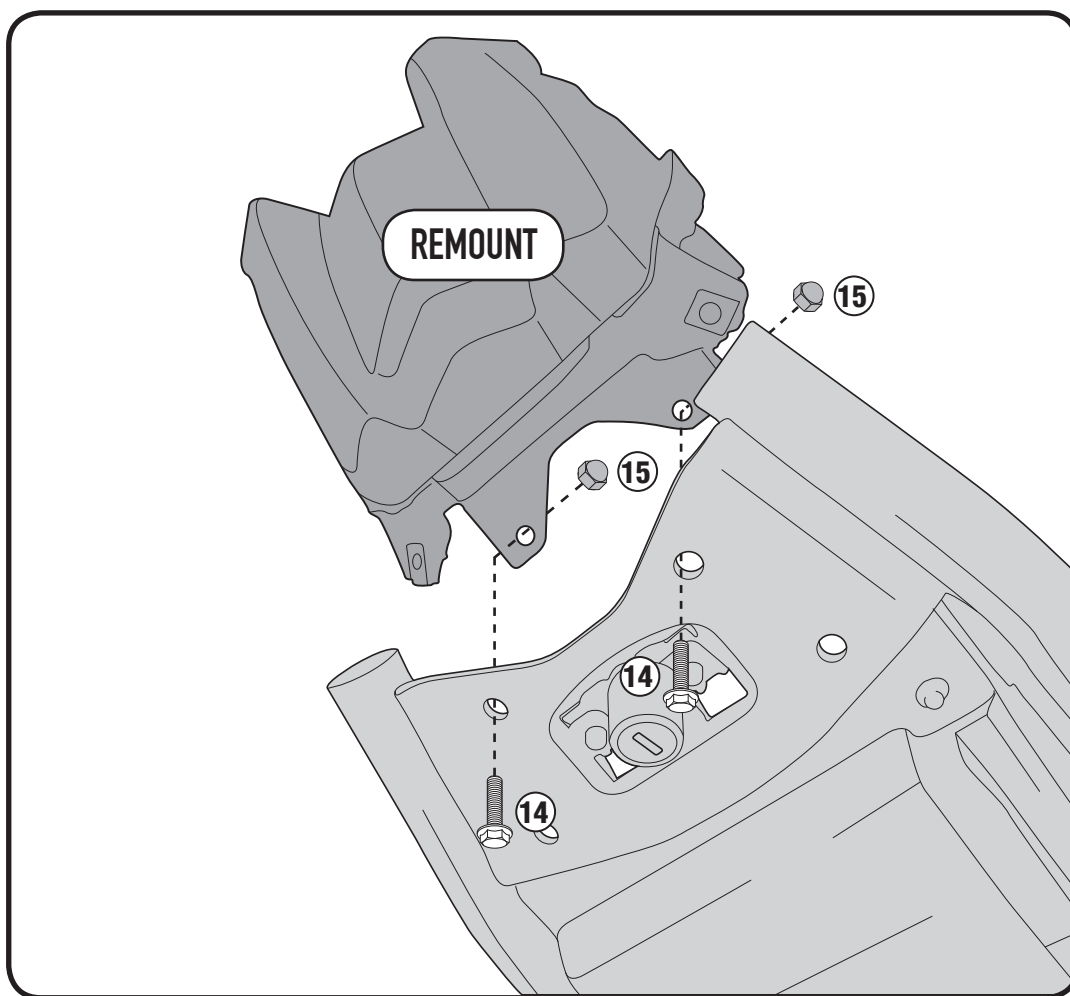
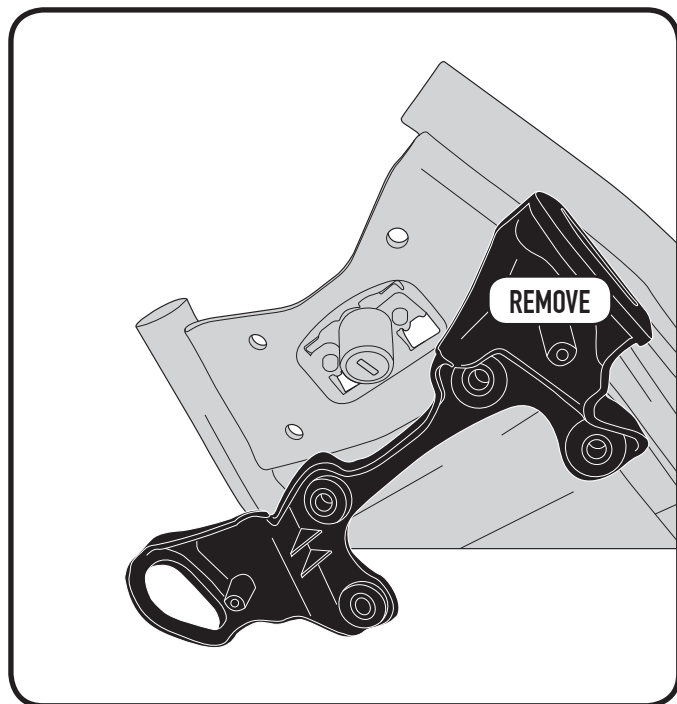
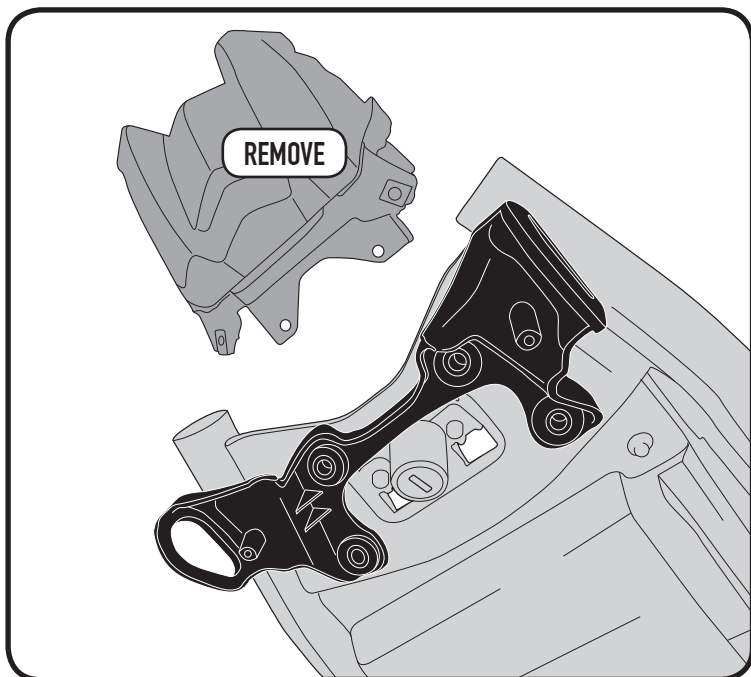

# 2132FZ - KZ2132

MONORACK SPECIFICO - SPECIFIC MONORACK - MONORACK SPECIFIQUE - SPEZIFISCHES MONORACK - MONORACK ESPECÍFICO - MONORACK ESPECÍFICA

## YAMAHA MT-09 (2017)

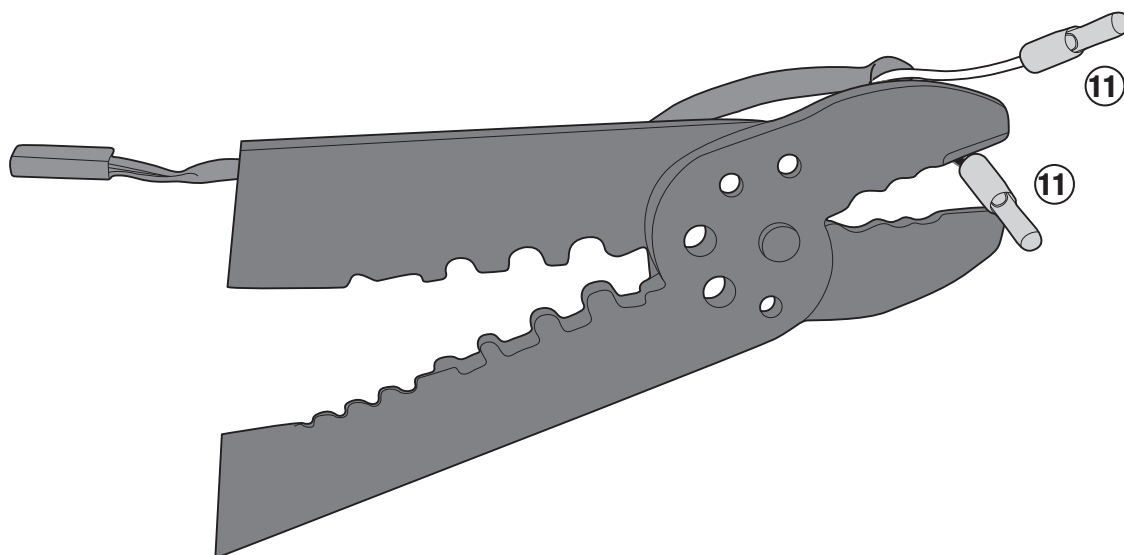
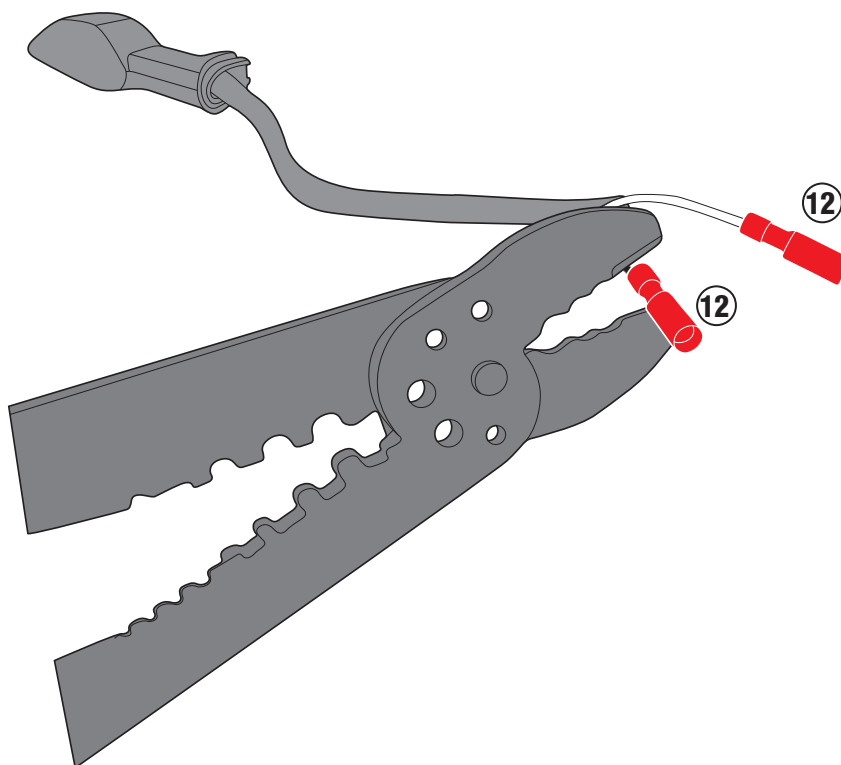
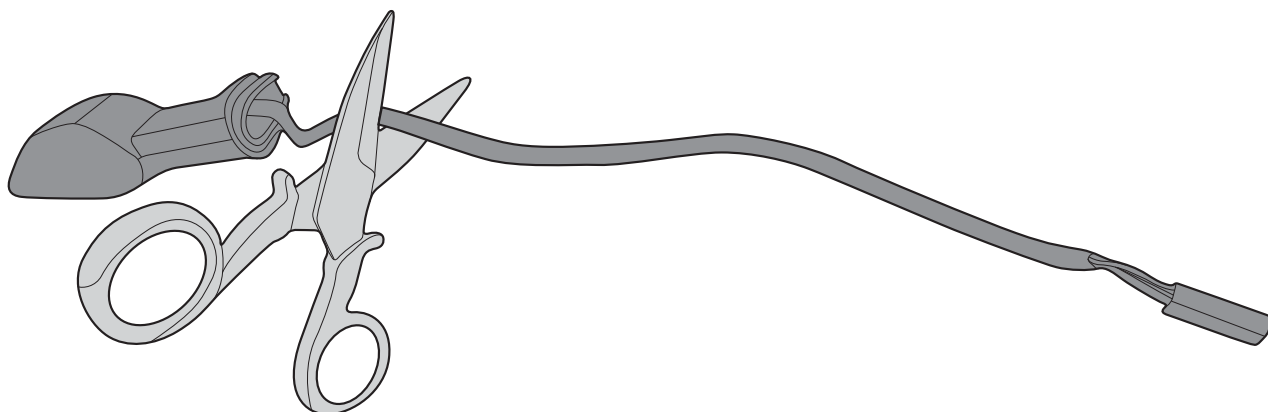

# 2132FZ - KZ2132

MONORACK SPECIFICO - SPECIFIC MONORACK - MONORACK SPECIFIQUE - SPEZIFISCHES MONORACK - MONORACK ESPECÍFICO - MONORACK ESPECÍFICA

## YAMAHA MT-09 (2017)

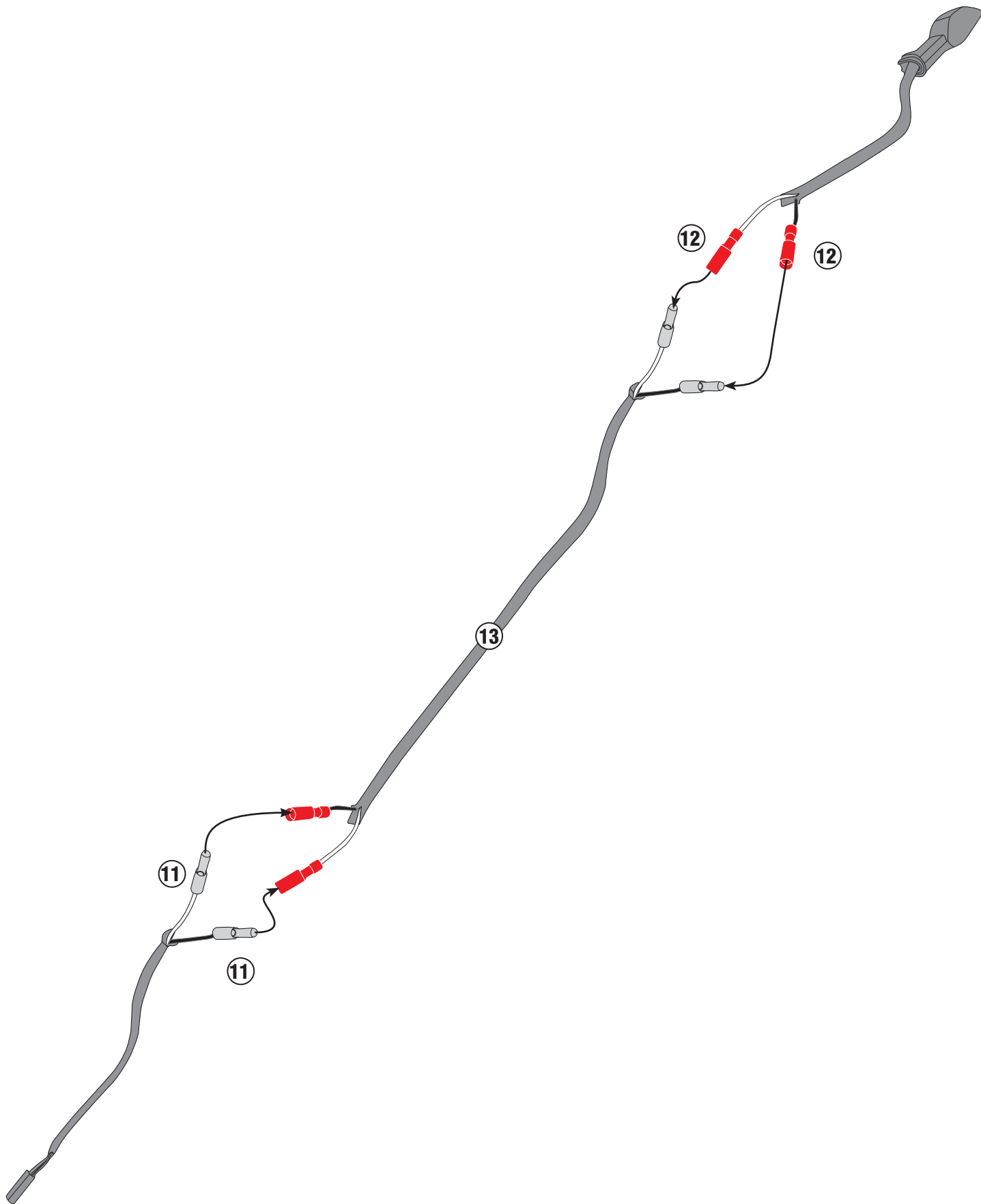

# 2132FZ - KZ2132

MONORACK SPECIFICO - SPECIFIC MONORACK - MONORACK SPECIFIQUE - SPEZIFISCHES MONORACK - MONORACK ESPECÍFICO - MONORACK ESPECÍFICA

## YAMAHA MT-09 (2017)

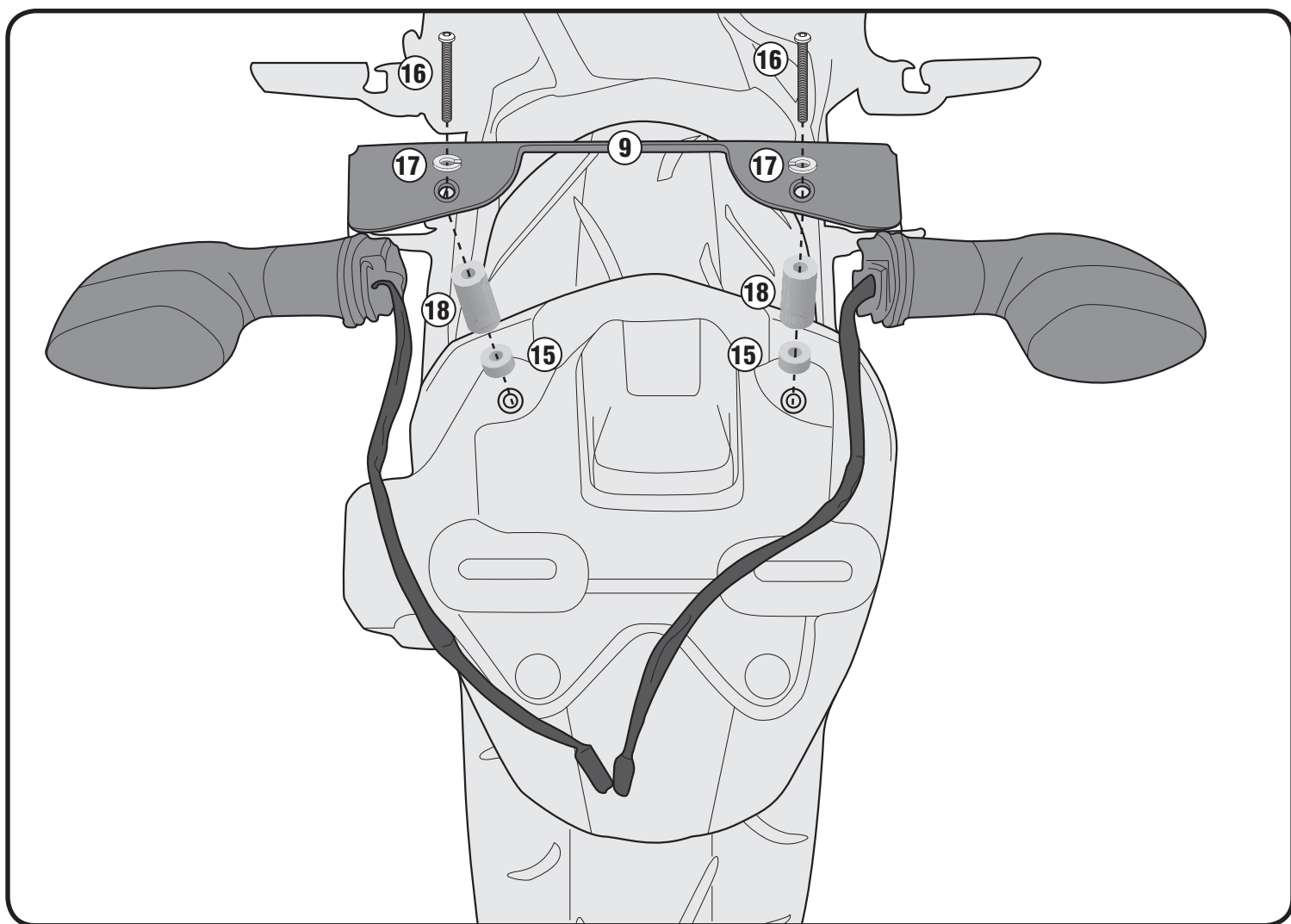
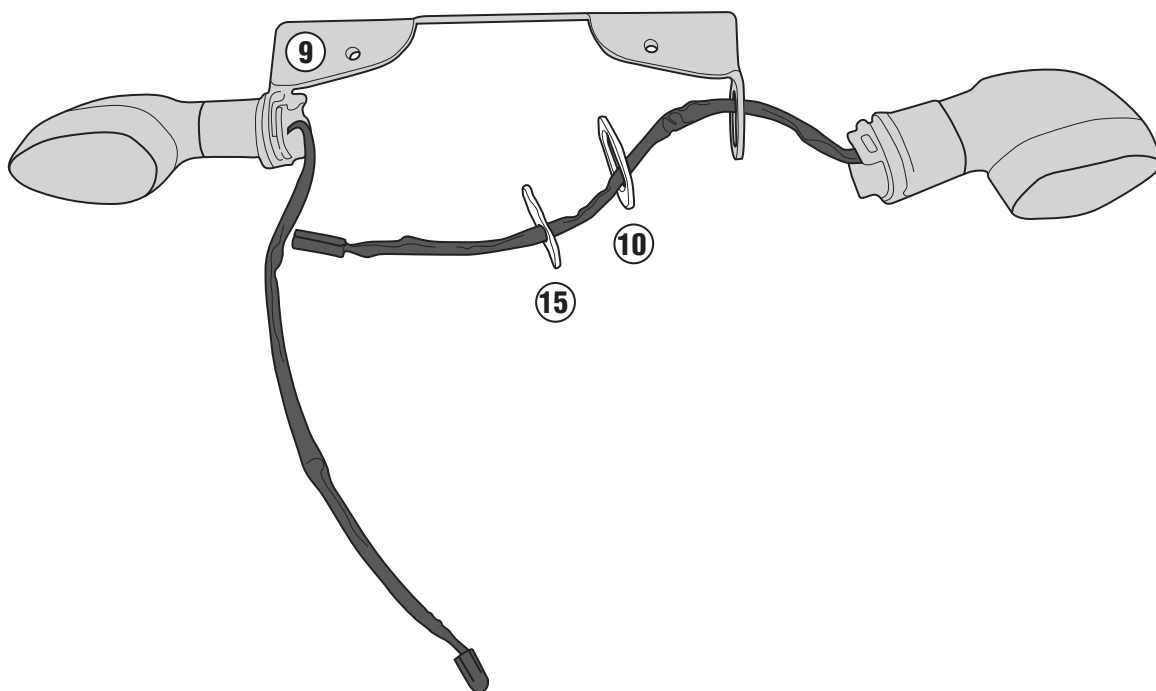

# 2132FZ - KZ2132

MONORACK SPECIFICO - SPECIFIC MONORACK - MONORACK SPECIFIQUE - SPEZIFISCHES MONORACK - MONORACK ESPECÍFICO - MONORACK ESPECÍFICA

## YAMAHA MT-09 (2017)

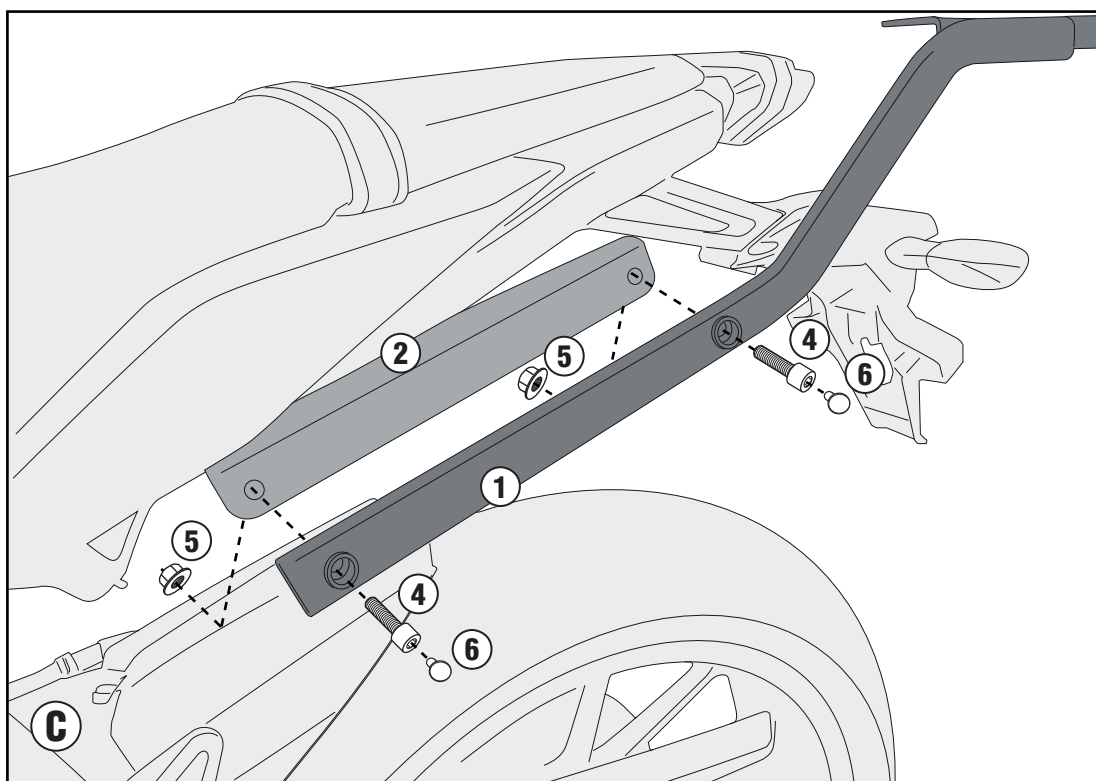
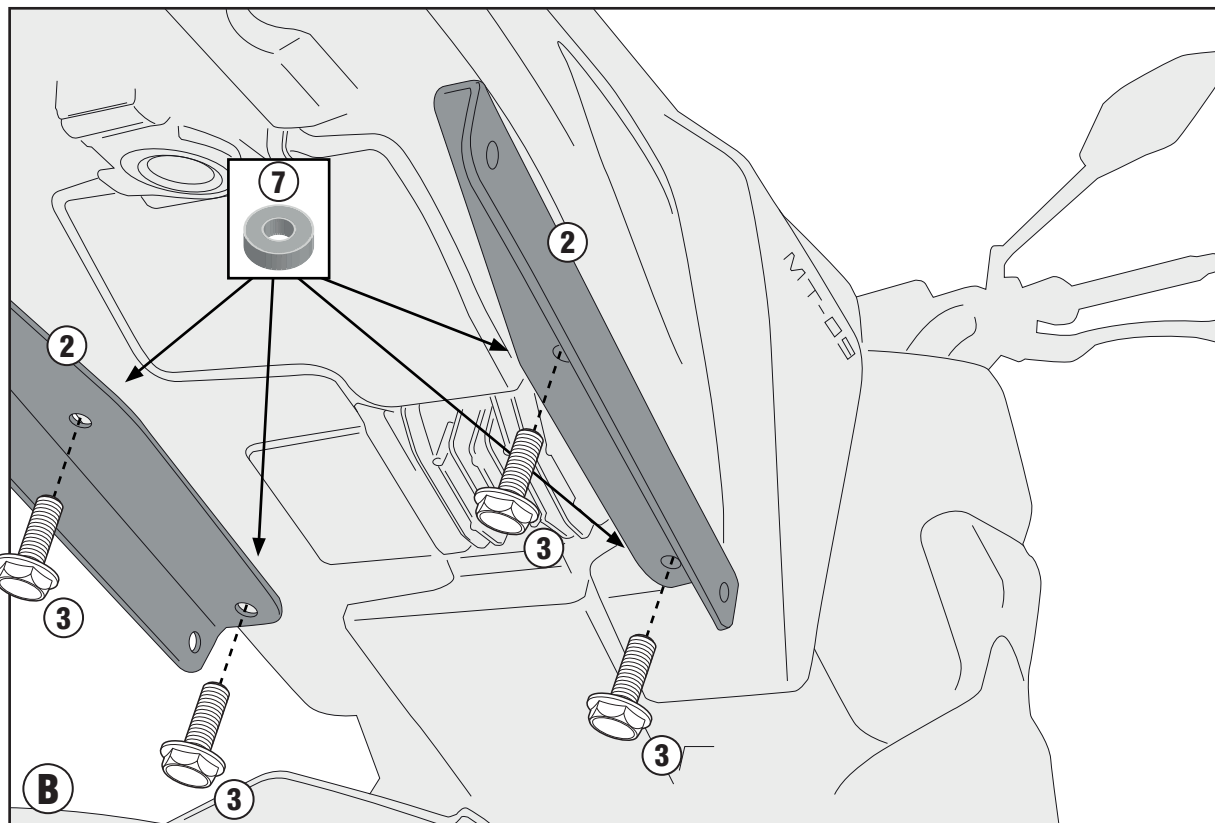



# 2132FZ - KZ2132

MONORACK SPECIFICO - SPECIFIC MONORACK - MONORACK SPECIFIQUE - SPEZIFISCHES MONORACK - MONORACK ESPECÍFICO - MONORACK ESPECÍFICA

## YAMAHA MT-09 (2017)

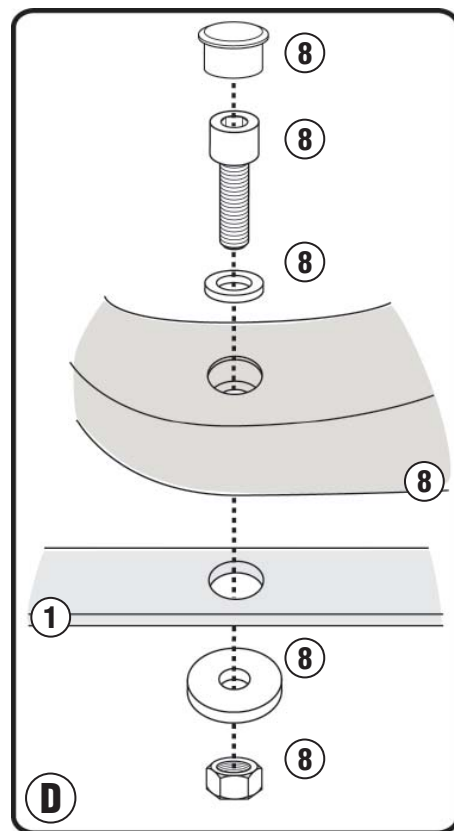
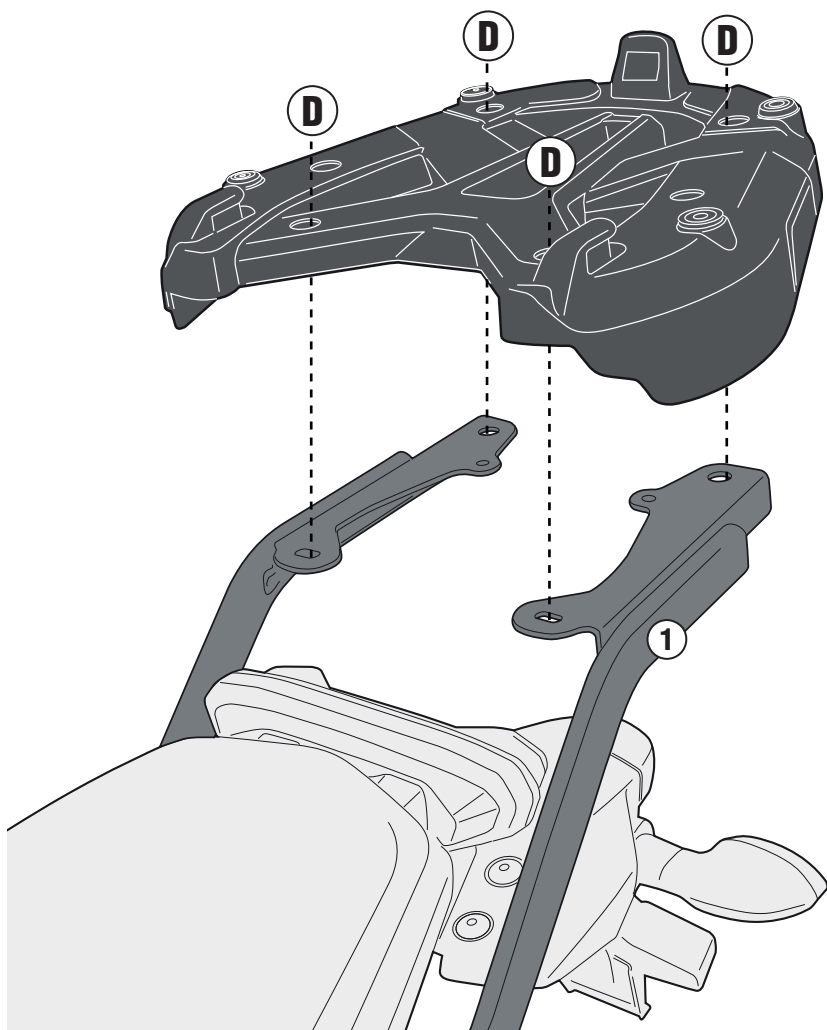

# 2132FZ - KZ2132

MONORACK SPECIFICO - SPECIFIC MONORACK - MONORACK SPECIFIQUE - SPEZIFISCHES MONORACK - MONORACK ESPECÍFICO - MONORACK ESPECÍFICA

## YAMAHA MT-09 (2017)

---

# 2132FZ - KZ2132

MONORACK SPECIFICO - SPECIFIC MONORACK - MONORACK SPECIFIQUE - SPEZIFISCHES MONORACK - MONORACK ESPECÍFICO - MONORACK ESPECÍFICA

## YAMAHA MT-09 (2017)

---

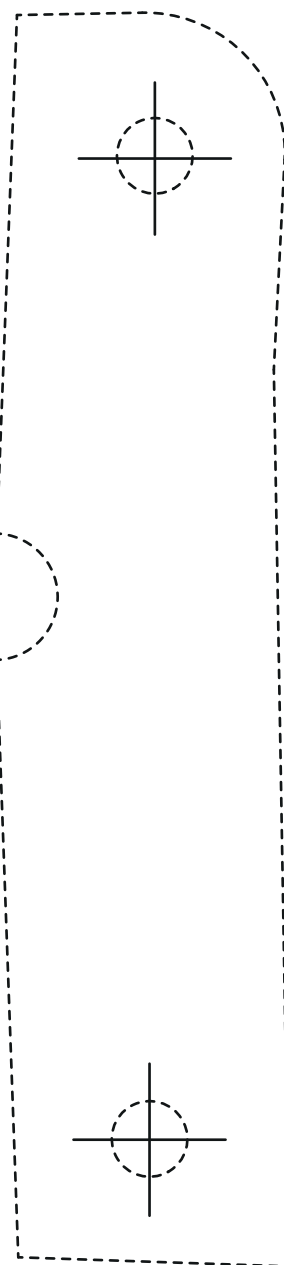
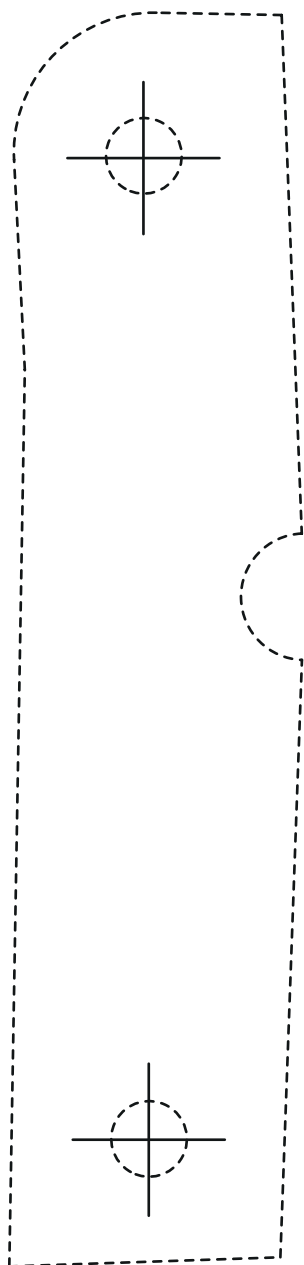

# 2132FZ - KZ2132

MONORACK SPECIFICO - SPECIFIC MONORACK - MONORACK SPECIFIQUE - SPEZIFISCHES MONORACK - MONORACK ESPECÍFICO - MONORACK ESPECÍFICA

## YAMAHA MT-09 (2017)

---