

# ES1139 - ES1139K

ESTENSIONE CAVALLETTO LATERALE - SIDE STAND EXTENSION - FUSSVERBREITERUNGEN FÜR SEITENSTÄNDER  
ZIJSTANDAARD EXTENSIE - EXTENSIÓN DEL CABALLETE LATERAL - EXTENSÃO DO CAVALETE LATERAL

## HONDA CROSSRUNNER 800 (2015)

N°	Descrizione	Caratteristiche	Codice	Quantità
1	Supporto - Support - Support Halierung - Soporte - Apoio	Alluminio Sp. 6mm	GL2936	1
2	Supporto - Support - Support Halierung - Soporte - Apoio	Alluminio Sp. 6mm	GL2937	1
3	Supporto - Support - Support Halierung - Soporte - Apoio	INOX Sp. 3mm	GL2938	1
4	Vite - Screw Vis - Schraube Tornillo - Parafuso	M5x12	-	4

①

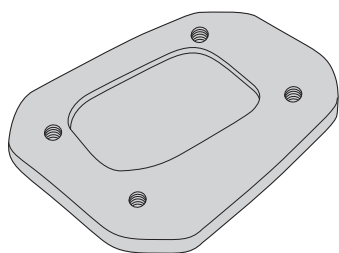

②

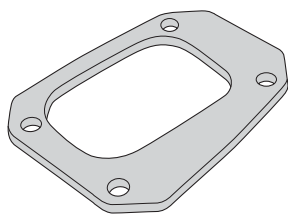

③

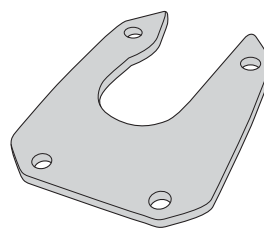

④

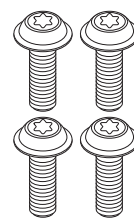

# ES1139 - ES1139K

ESTENSIONE CAVALLETTO LATERALE - SIDE STAND EXTENSION - FUSSVERBREITERUNGEN FÜR SEITENSTÄNDER  
ZIJSTANDAARD EXTENSIE - EXTENSIÓN DEL CABALLETE LATERAL - EXTENSÃO DO CAVALETE LATERAL

## HONDA CROSSRUNNER 800 (2015)

ATTENZIONE: IL MONTAGGIO DELL' ESTENSIONE DEL CAVALLETTO, POTREBBE LIMITARE IL GRADO DI LIBERTÀ DI INCLINAZIONE DELLA MOTO.  
APPLICARE ALCUNE GOCCE DI FRENA FILETTI SULLE VITI DI FISSAGGIO.

ATTENTION: MOUNTING OF STAND EXTENSION, COULD LIMIT LEAN ANGLE.  
APPLY SOME THREADLOCK ON THE SCREWS

ATTENTION: MONTAGE DE L'EXTENSION DU PEUPEMENT, POURRAIT LIMITER L'ANGLE D'INCLINAISON.  
APPLIQUER UN PEU DE FREIN-FILET SUR LES VIS

ACHTUNG: DER ANBAU DER FUSSVERBREITERUNGEN FÜR SEITENSTÄNDER KANN EINFLUSS AUF DIE SCHRÄGLAGENFREIHEIT DES FAHRZEUGS HABEN.  
BRINGEN SIE ETWAS GEWINDEKLE AUF DEN SCHRAUBEN

ATENCIÓN: MONTAJE DE EXTENSIÓN SOPORTE, PODRÍA LIMITAR ÁNGULO DE INCLINACIÓN.  
APLIQUE UN POCO DE FIJADOR DE ROSCAS EN LOS TORNILLOS

ATENÇÃO: MONTAGEM DE SUPORTE DE EXTENSÃO, PODERIA LIMITAR O ÂNGULO DE INCLINAÇÃO.  
APLIQUE UM POUCO DE MASSA DE BLOQUEIO DE ROSCAS NOS PARAFUSOS

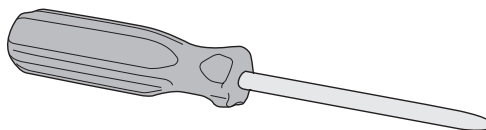
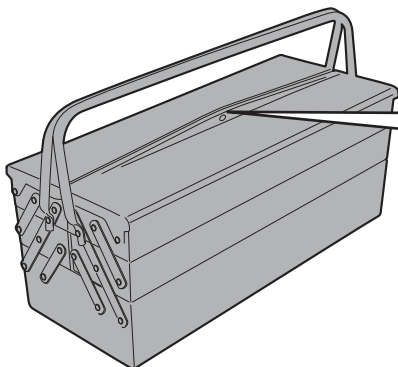
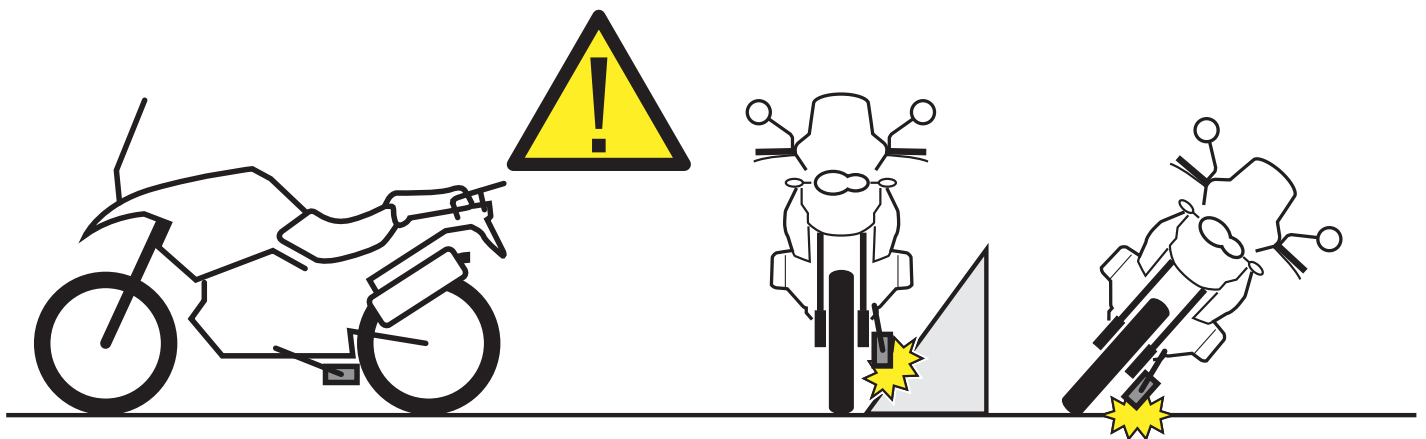

# ES1139 - ES1139K

ESTENSIONE CAVALLETTO LATERALE - SIDE STAND EXTENSION - FUSSVERBREITERUNGEN FÜR SEITENSTÄNDER  
ZIJSTANDAARD EXTENSIE - EXTENSIÓN DEL CABALLETE LATERAL - EXTENSÃO DO CAVALETE LATERAL

## HONDA CROSSRUNNER 800 (2015)

