

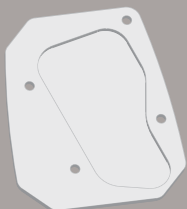





ES6408 - ES6408K

ESTENSIONE CAVALLETTO LATERALE - SIDE STAND EXTENSION - FUSSVERBREITERUNGEN FÜR SEITENSTÄNDER

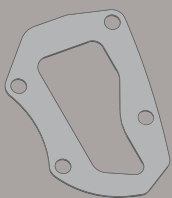
ZIJSTANDAARD EXTENSIE - EXTENSIÓN DEL CABALLETE LATERAL - EXTENSÃO DO CAVALETE LATERAL

TRIUMPH TIGER EXPLORER 1200 (2017)

N°	Descrizione	Caratteristiche	Codice	Quantità	
1	Supporto - Support - Support Halterung - Soporte - Apoio	Alluminio Sp. 6mm	GL2592	1	
2	Supporto - Support - Support Halterung - Soporte - Apoio	INOX 316, Sp.2mm	GL2593	1	
3	Supporto - Support - Support Halterung - Soporte - Apoio	INOX 316, Sp.2mm	GL2594	1	
4	Protezioni In Gomma - Protective Rubber Pads Protections En Caoutchouc - Schutzgummis Goma Protectora - Protetor De Borracha	-	Z2299	1	
5	Distanziale - Spacer Entretoise - Distanzstueck Distanciador - Espaçador	Ø8x4,5 Foro 6,2 mm	-	4	
6	Vite - Screw Vis - Schraube Tornillo - Parafuso	M5x14	-	4	
7	Vite - Screw Vis - Schraube Tornillo - Parafuso	M5x22	-	4	
8	Distanziale - Spacer Entretoise - Distanzstueck Distanciador - Espaçador	Ø8x12 Foro 5 mm	C8L12F5	4	

ES6408 - ES6408K

ESTENSIONE CAVALLETTO LATERALE - SIDE STAND EXTENSION - FUSSVERBREITERUNGEN FÜR SEITENSTÄNDER
ZIJSTANDAARD EXTENSIE - EXTENSIÓN DEL CABALLETE LATERAL - EXTENSÃO DO CAVALETE LATERAL

TRIUMPH TIGER EXPLORER 1200 (2017)

ATTENZIONE: IL MONTAGGIO DELL' ESTENSIONE DEL CAVALLETTO, POTREBBE LIMITARE IL GRADO DI LIBERTÀ DI INCLINAZIONE DELLA MOTO.
APPLICARE ALCUNE GOCCE DI FRENA FILETTI SULLE VITI DI FISSAGGIO.

ATTENTION: MOUNTING OF STAND EXTENSION, COULD LIMIT LEAN ANGLE.
APPLY SOME THREADLOCK ON THE SCREWS

ATTENTION: MONTAGE DE L'EXTENSION DU PEUPEMENT, POURRAIT LIMITER L'ANGLE D'INCLINAISON.
APPLIQUER UN PEU DE FREIN-FILET SUR LES VIS

ACHTUNG: DER ANBAU DER FUSSVERBREITERUNGEN FÜR SEITENSTÄNDER KANN EINFLUSS AUF DIE SCHRÄGLAGENFREIHEIT DES FAHRZEUGS HABEN.
BRINGEN SIE ETWAS GEWINDEKLE AUF DEN SCHRAUBEN

ATENCIÓN: MONTAJE DE EXTENSIÓN SOPORTE, PODRÍA LIMITAR ÁNGULO DE INCLINACIÓN.
APLIQUE UN POCO DE FIJADOR DE ROSCAS EN LOS TORNILLOS

ATENÇÃO: MONTAGEM DE SUPORTE DE EXTENSÃO, PODERIA LIMITAR O ÂNGULO DE INCLINAÇÃO.
APLIQUE UM POUCO DE MASSA DE BLOQUEIO DE ROSCAS NOS PARAFUSOS

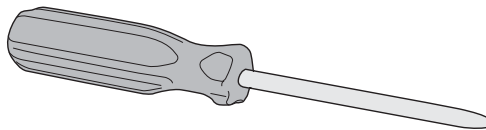
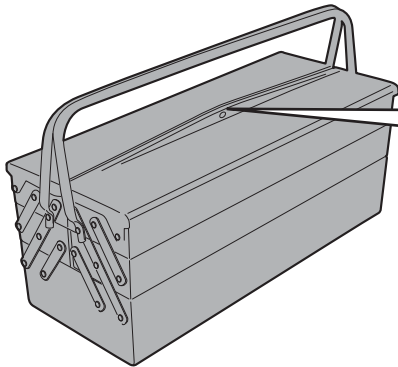
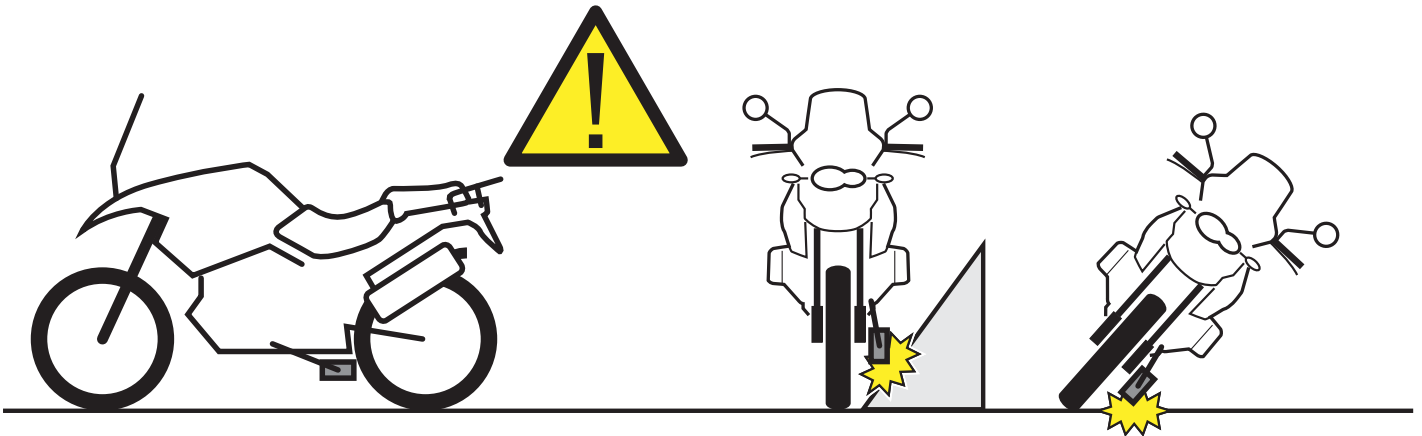

ES6408 - ES6408K

ESTENSIONE CAVALLETTO LATERALE - SIDE STAND EXTENSION - FUSSVERBREITERUNGEN FÜR SEITENSTÄNDER
ZIJSTANDAARD EXTENSIE - EXTENSIÓN DEL CABALLETE LATERAL - EXTENSÃO DO CAVALETE LATERAL

TRIUMPH TIGER EXPLORER 1200 (2017)

TIGER EXPLORER 1200 (2017)

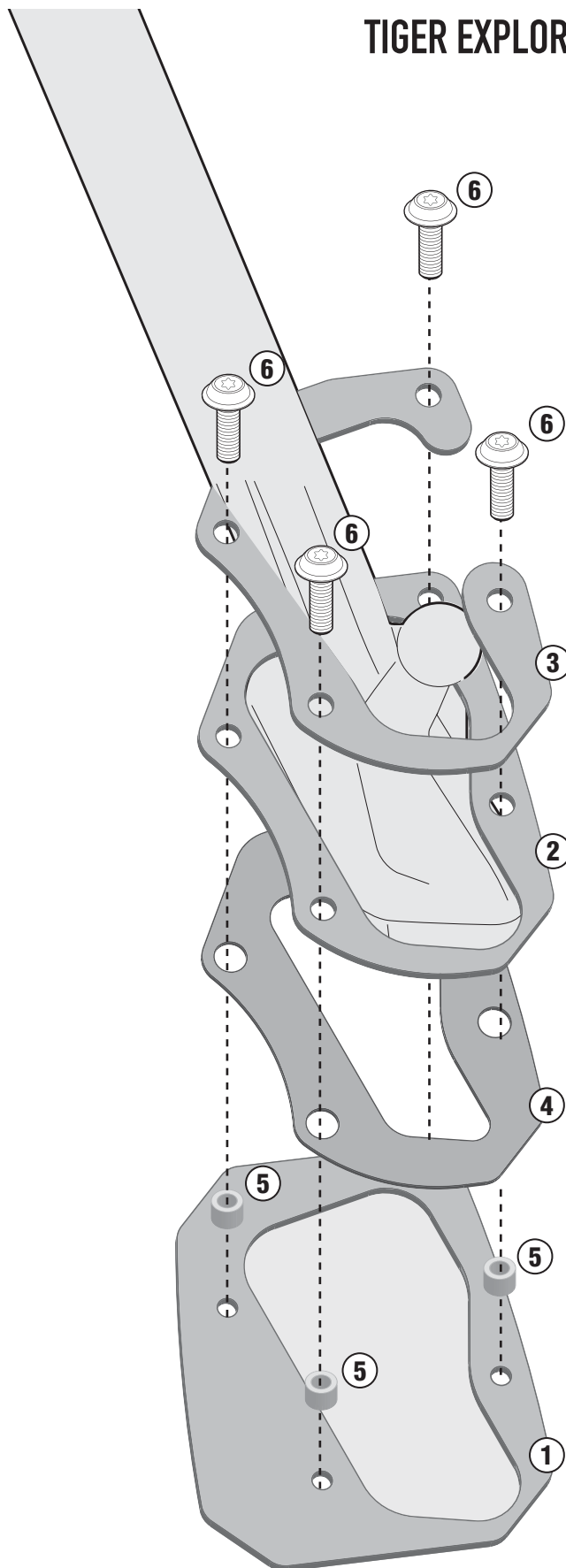

ES6408 - ES6408K

ESTENSIONE CAVALLETTO LATERALE - SIDE STAND EXTENSION - FUSSVERBREITERUNGEN FÜR SEITENSTÄNDER
ZIJSTANDAARD EXTENSIE - EXTENSIÓN DEL CABALLETE LATERAL - EXTENSÃO DO CAVALETE LATERAL

TRIUMPH TIGER EXPLORER 1200 (2017)

TIGER EXPLORER 1200 (2012-2015)

