

# PLXR2122 - KLXR2122

PORTAVALIGIE LATERALE SPECIFICO - SPECIFIC TUBULAR SIDE-CASE HOLDER - PORTE-VALISES LATÉRAUX SPÉCIFIQUE - SPEZIFISCHES STAHLROHR-SEITENTRAEGER  
PORTA MALETAS LATERALES ESPECÍFICO

## YAMAHA MT-09 TRACER (2015/2017)

N°	Descrizione	Caratteristiche	Codice	Quantità
1	Supporto - Support - Support Halterung - Soporte - Apoio	-	PLXR2122 (Dx - Sx)	2 (Dx, Sx)
2	Supporto - Support - Support Halterung - Soporte - Apoio	-	GNB1363P	1
3	Supporto - Support - Support Halterung - Soporte - Apoio	-	GL2823 (Dx - Sx)	2 (Dx - Sx)
4	Supporto - Support - Support Halterung - Soporte - Apoio	-	Z2379	4
5	Vite - Screw Vis - Schraube Tornillo - Parafuso	TEF M6x16	616TEF	4
6	Vite - Screw Vis - Schraube Tornillo - Parafuso	TBEI M8x25	825TBEI	4
7	Rondella - Washer - Rondelle Scheibe - Arandela - Arruela	Ø 25 Foro 8mm	258RON	2
8	Distanziale - Spacer Entretoise - Distanzstueck Distanciador - Espaçador	-	C24L5F8,5T	2
9	Chiave Per Viti A Testa Speciale Special Key - Cle Speciale Spezialschlüssel Zur Demontage Des Trägers Llave Para Tornillos Con Cabeza Especial	-	CHIAVE PLXRC	1
10	Particolari Inclusi Nel Kit Viteria Del SR2122 Components Included In The Fitting Kit Of The SR2122 Pièces Incluses Dans Le Kit De Vis De SR2122 Die Einzelnen Teile Sind Bei Montagekit Der SR2122 Despieces Incluidos En El Kit De Anclajes De SR2122 Explodiu Incluído No Kit As SR2122	-	-	-

# PLXR2122 - KLXR2122

PORTAVALIGIE LATERALE SPECIFICO - SPECIFIC TUBULAR SIDE-CASE HOLDER - PORTE-VALISES LATÉRAUX SPÉCIFIQUE - SPEZIFISCHES STAHLROHR-SEITENTRAEGER  
PORTA MALETAS LATERALES ESPECÍFICO

## YAMAHA MT-09 TRACER (2015/2017)

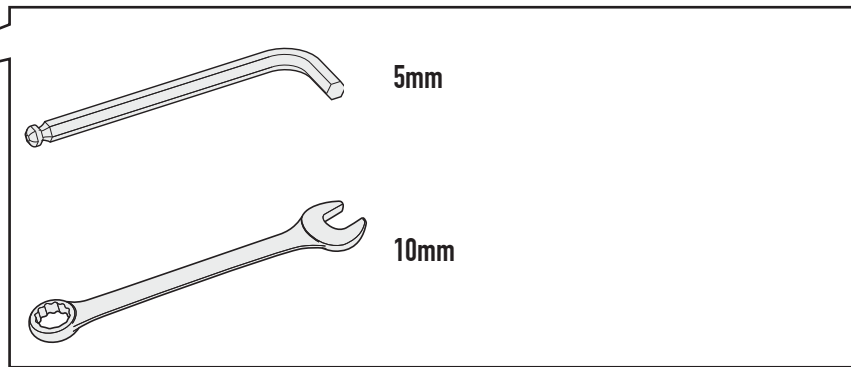
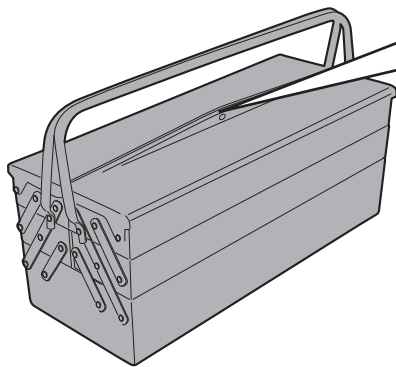
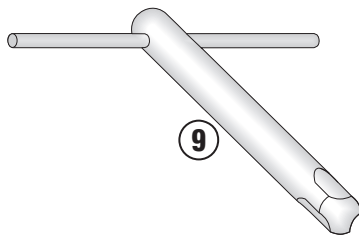
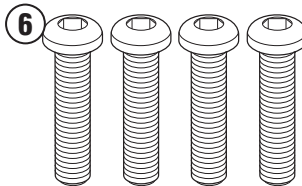
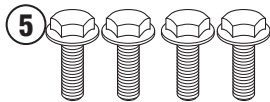
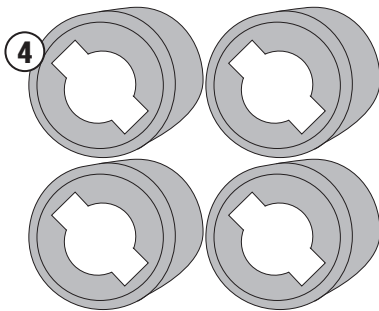
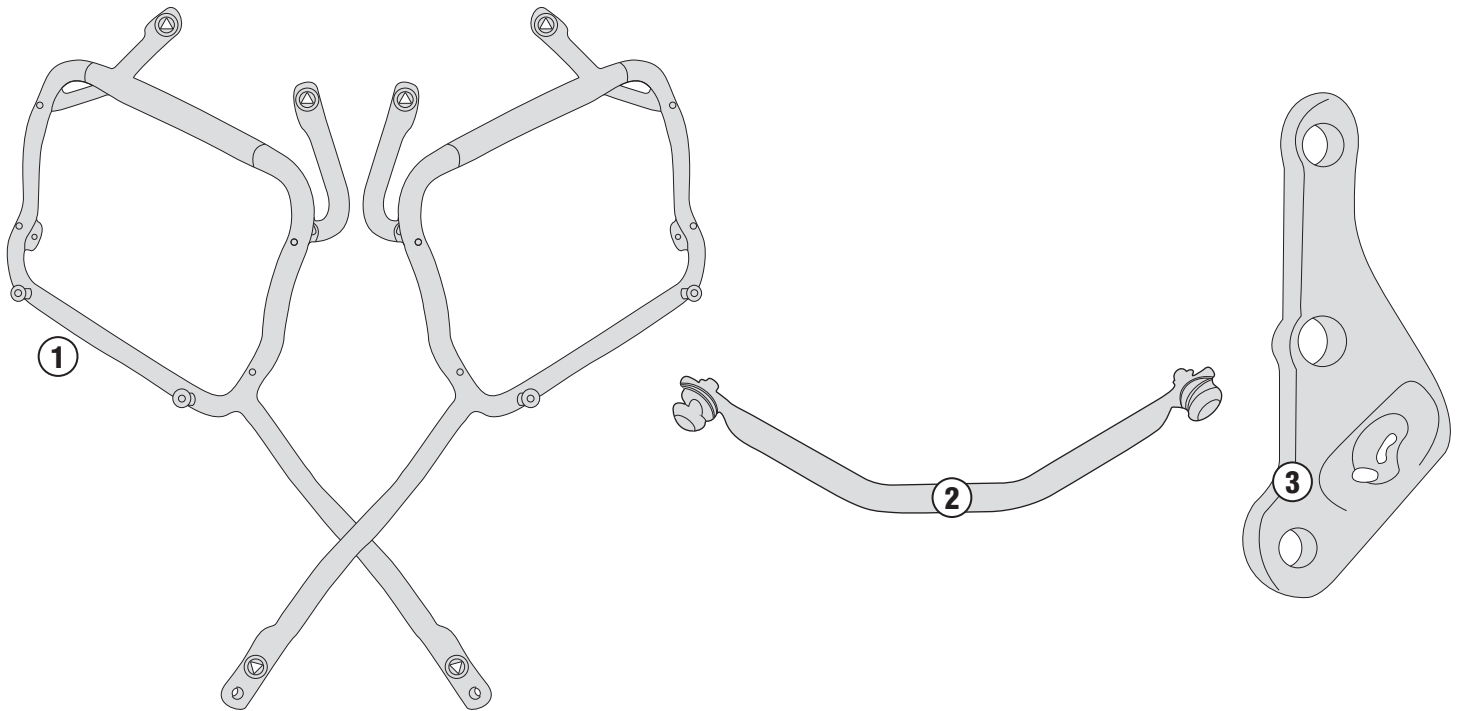

# PLXR2122 - KLXR2122

PORTAVALIGIE LATERALE SPECIFICO - SPECIFIC TUBULAR SIDE-CASE HOLDER - PORTE-VALISES LATÉRAUX SPÉCIFIQUE - SPEZIFISCHES STAHLROHR-SEITENTRAEGER  
PORTA MALETAS LATERALES ESPECÍFICO

## YAMAHA MT-09 TRACER (2015/2017)

PLXR2122 + SR2122

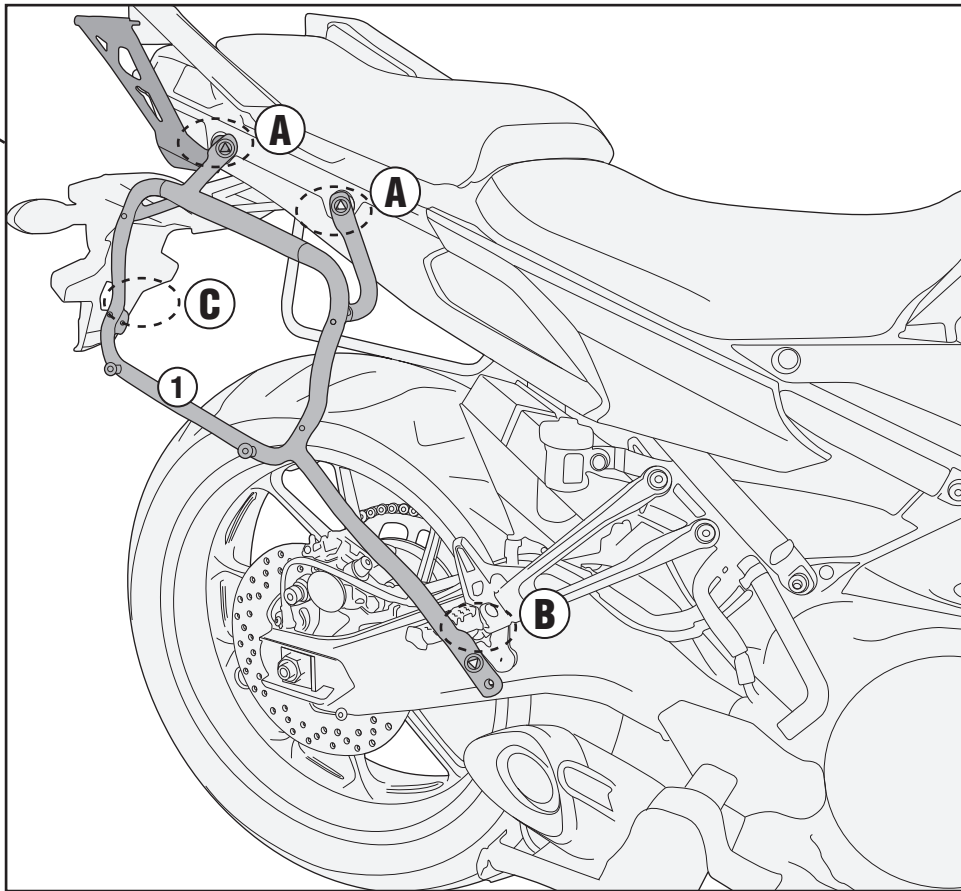

ONLY PLXR2122

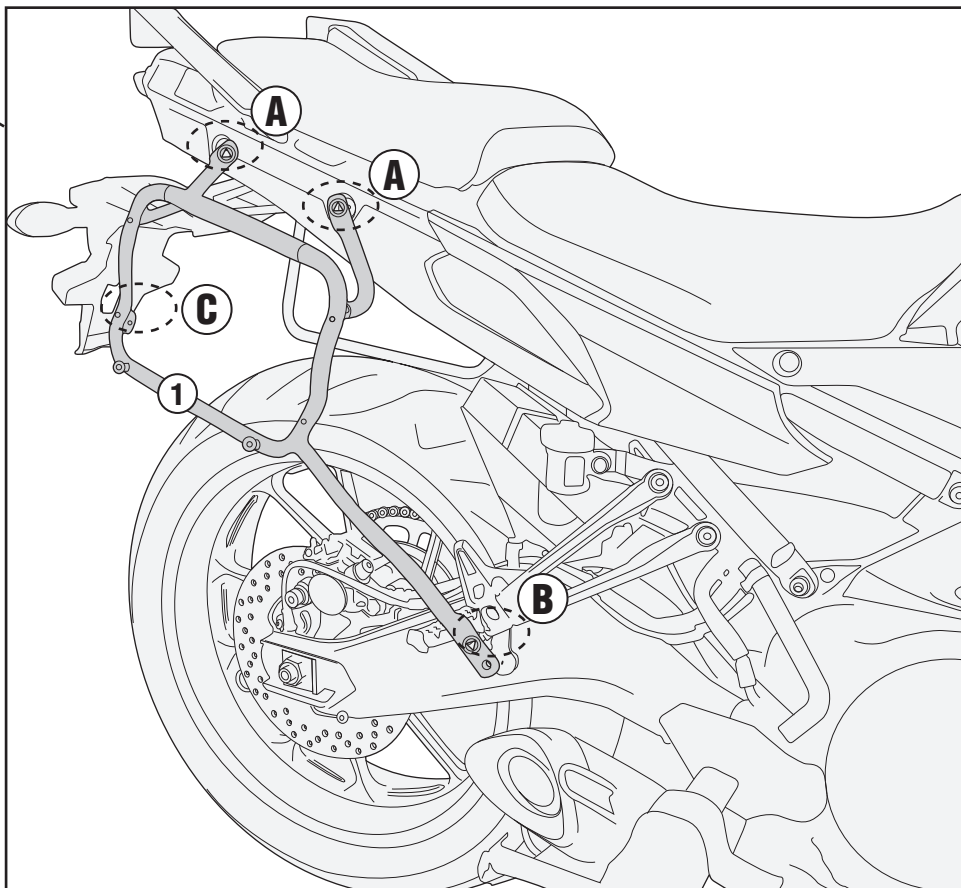

# PLXR2122 - KLXR2122

PORTAVALIGIE LATERALE SPECIFICO - SPECIFIC TUBULAR SIDE-CASE HOLDER - PORTE-VALISES LATÉRAUX SPÉCIFIQUE - SPEZIFISCHES STAHLROHR-SEITENTRAEGER  
PORTA MALETAS LATERALES ESPECÍFICO

## YAMAHA MT-09 TRACER (2015/2017)

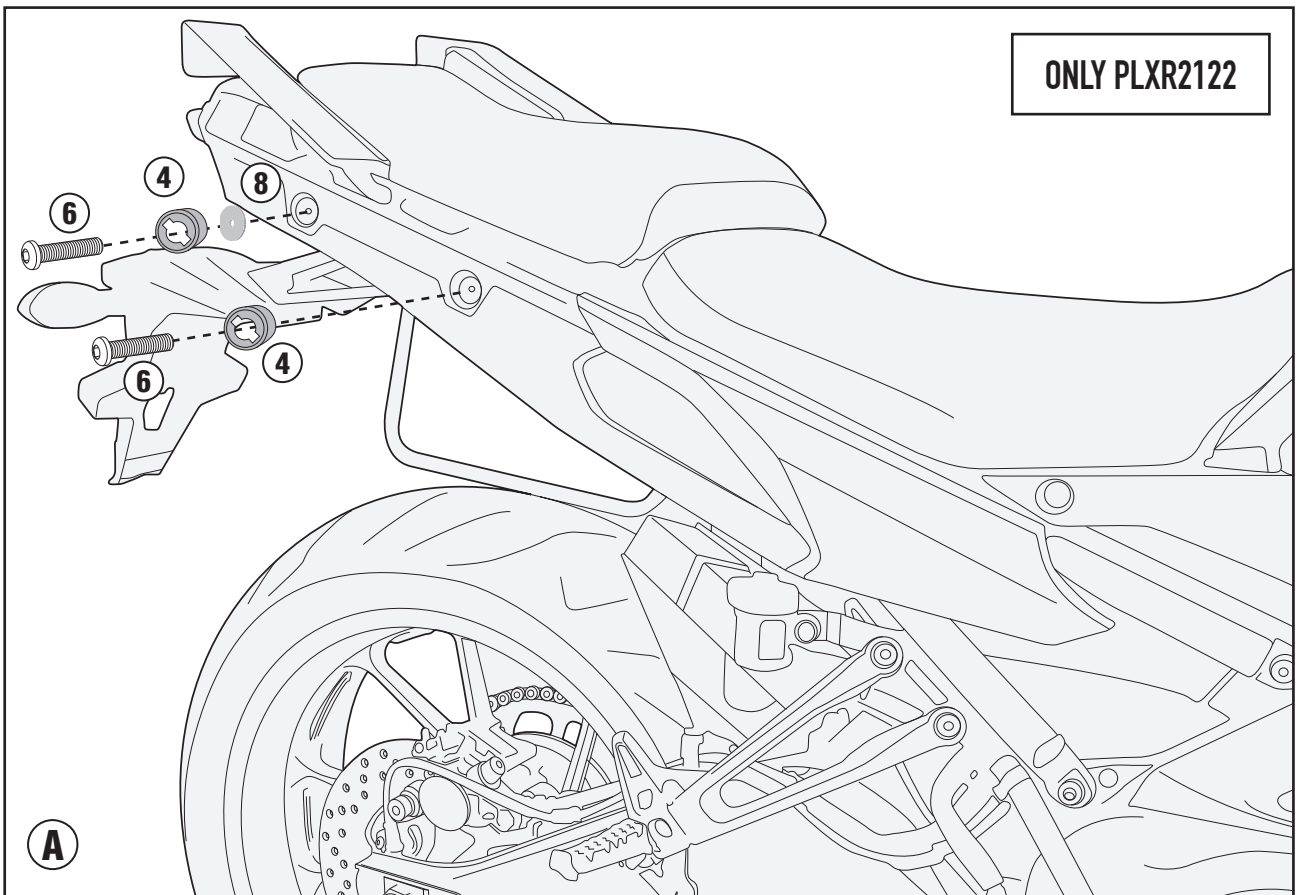
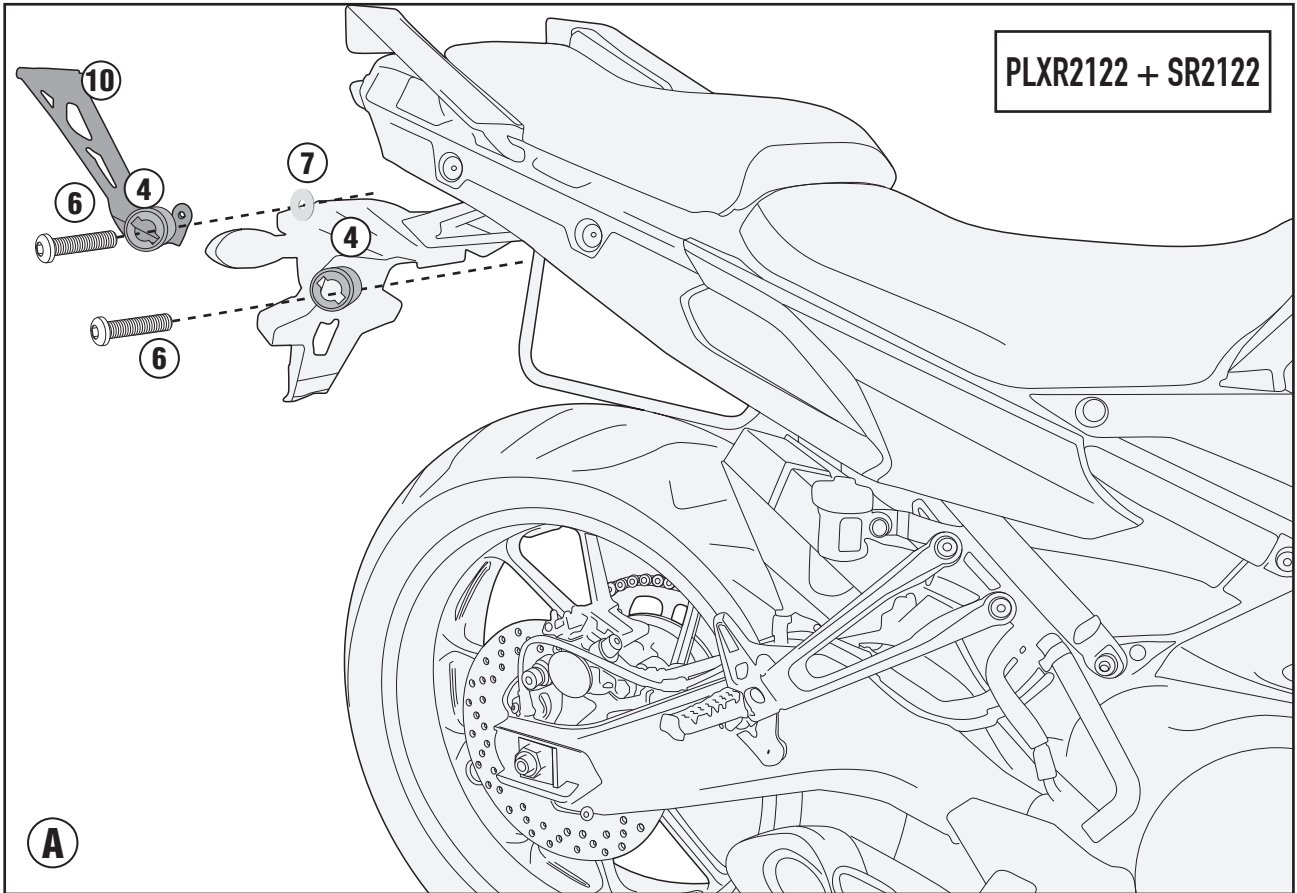

# PLXR2122 - KLXR2122

PORTAVALIGIE LATERALE SPECIFICO - SPECIFIC TUBULAR SIDE-CASE HOLDER - PORTE-VALISES LATÉRAUX SPÉCIFIQUE - SPEZIFISCHES STAHLROHR-SEITENTRAEGER  
PORTA MALETAS LATERALES ESPECÍFICO

## YAMAHA MT-09 TRACER (2015/2017)

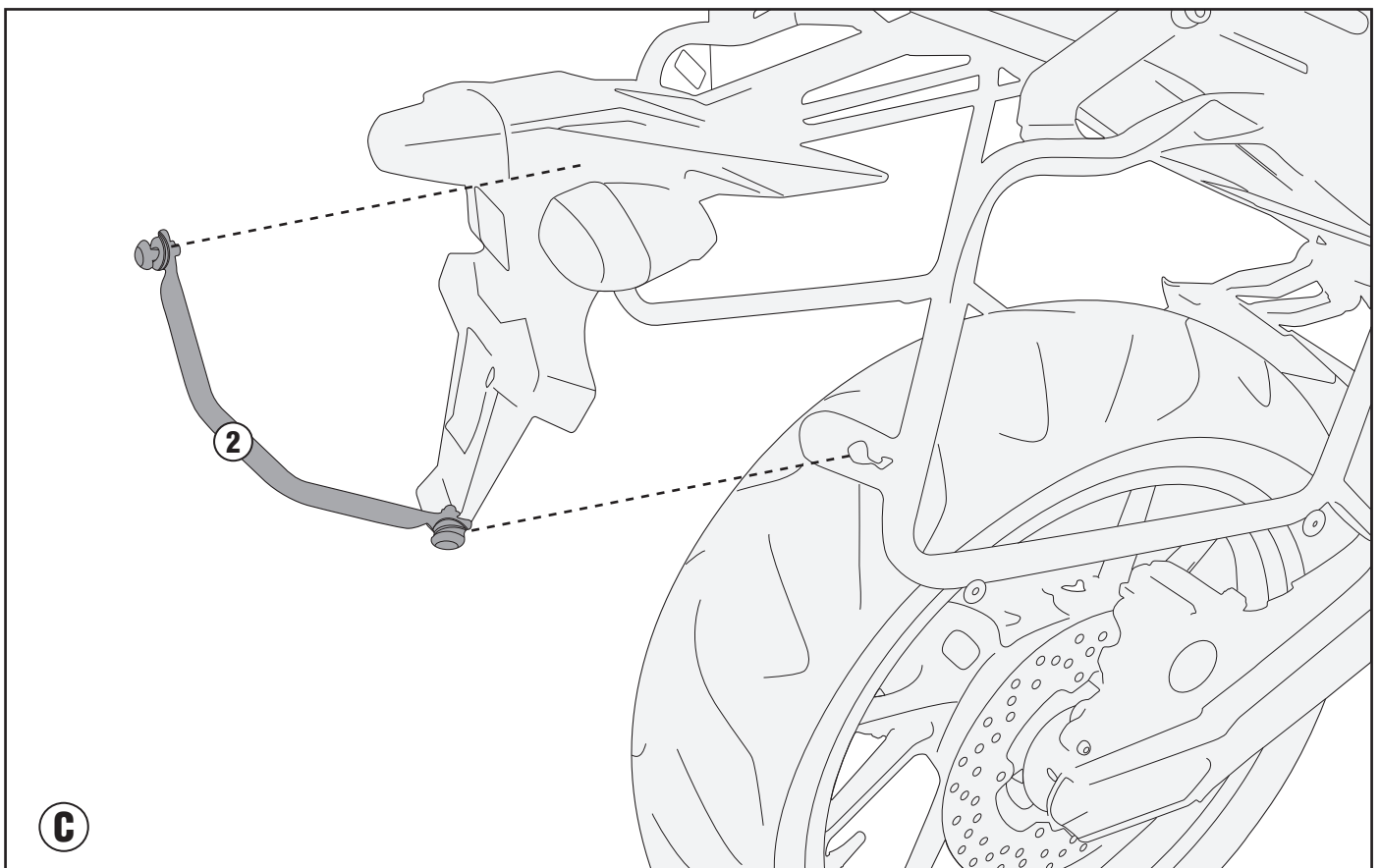
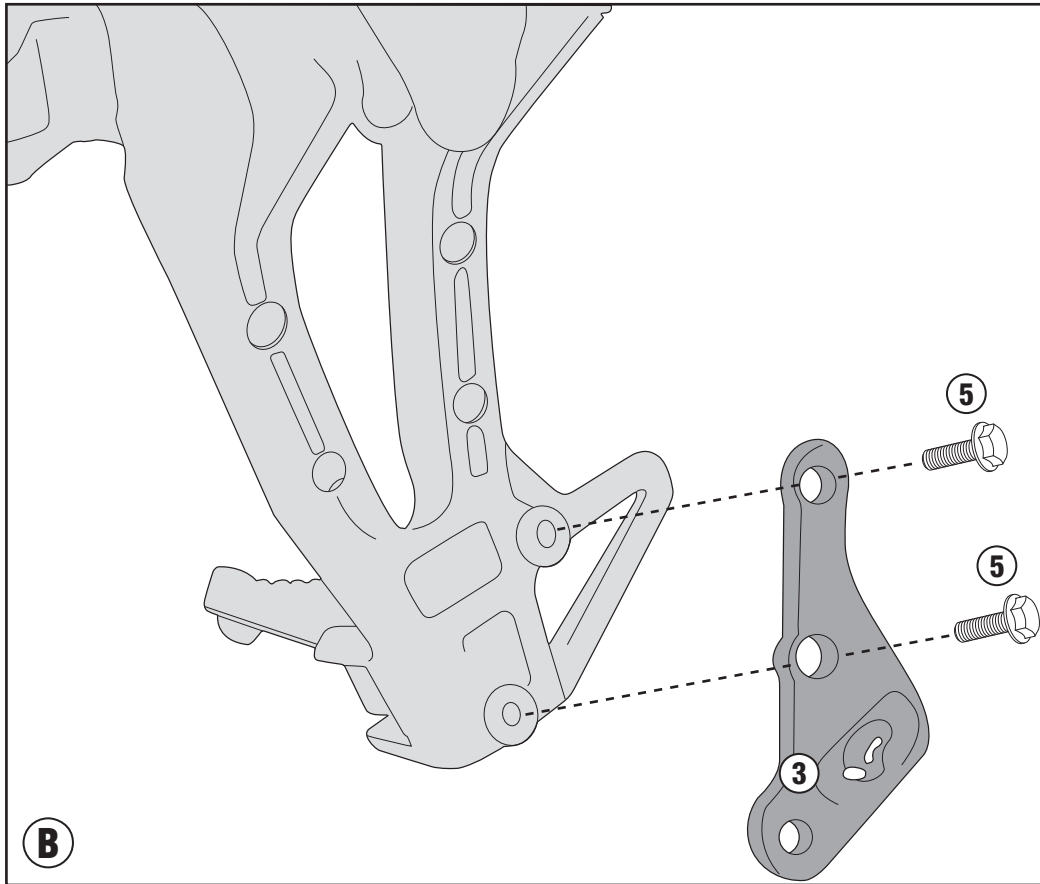

# PLXR2122 - KLXR2122

PORTAVALIGIE LATERALE SPECIFICO - SPECIFIC TUBULAR SIDE-CASE HOLDER - PORTE-VALISES LATÉRAUX SPÉCIFIQUE - SPEZIFISCHES STAHLROHR-SEITENTRAEGER  
PORTA MALETAS LATERALES ESPECÍFICO

## YAMAHA MT-09 TRACER (2015/2017)

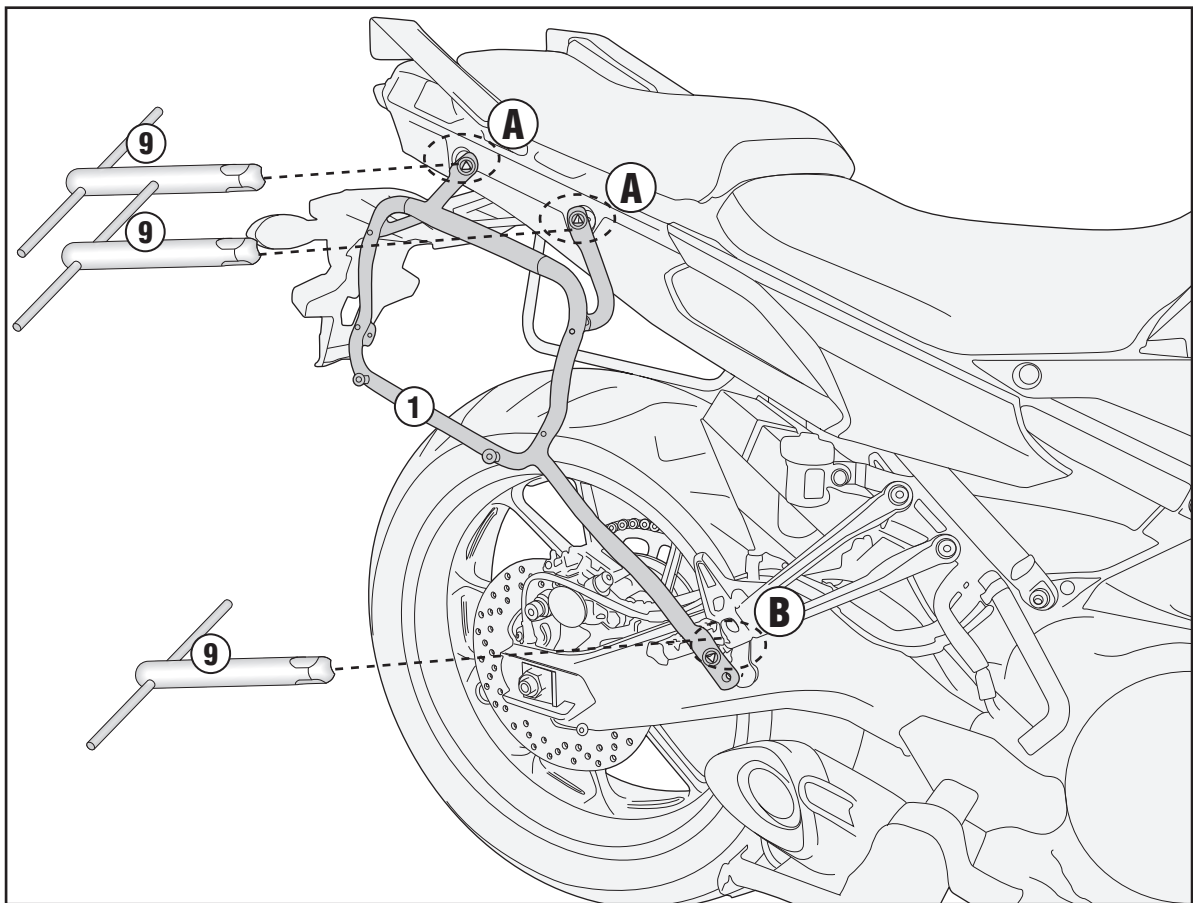

# PLXR2122 - KLXR2122

PORTAVALIGIE LATERALE SPECIFICO - SPECIFIC TUBULAR SIDE-CASE HOLDER - PORTE-VALISES LATÉRAUX SPÉCIFIQUE - SPEZIFISCHES STAHLROHR-SEITENTRAEGER  
PORTA MALETAS LATERALES ESPECÍFICO

## YAMAHA MT-09 TRACER (2015/2017)

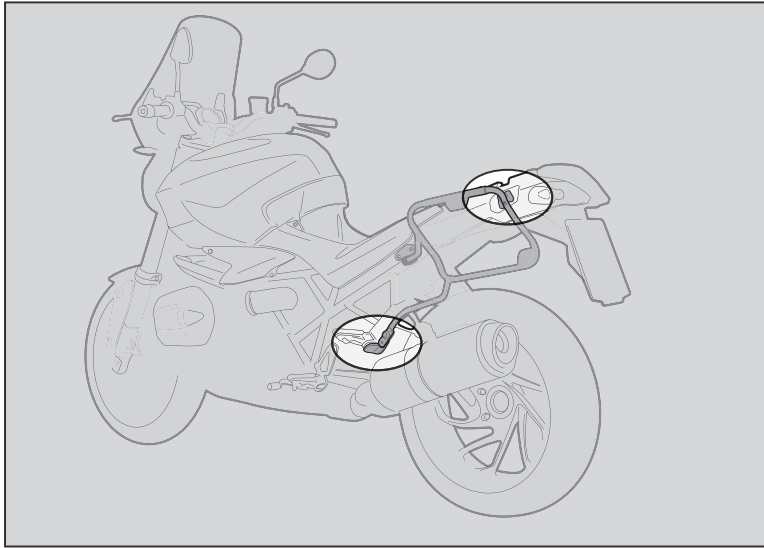

1. INSERIRE L'ATTREZZO NELLA TESTA DELLA VITE SPECIALE;
2. RUOTARE DI 1/4 DI GIRO IN SENSO ORARIO FINO A CHE LA ROTAZIONE NON TERMINA E SI AVVERTE LO SCATTO;
3. PER SMONTARE PROCEDERE IN SENSO INVERSO.

1. INSERT THE SPECIAL KEY INTO THE HEAD OF THE SCREW;
2. TURN THE KEY ¼ TURN CLOCKWISE UNTIL ROTATION STOPS AND THE SIDE CASE HOLDER IS FASTENED SECURELY TO THE FITMENT POINT;
3. IN ORDER TO DISASSEMBLE THE BRACKETRY PERFORM THE OPERATION IN REVERSE.

1. INSERER LA CLE SPECIALE DANS LA TÊTE DE LA VIS;
2. VISSER D'1/4 DE TOUR DANS LE SENS HORAIRE JUSQU'AU BLOCAGE DE LA VIS POUR MONTER EN TOUTE SECURITE LE SUPPORT A SON POINT DE FIXATION;
3. POUR LE DEMONTAGE, PROCEDER EN SENS INVERSE.

1. STECKEN SIE DAS WERKZEUG IN DEN KOPF DER SPEZIFISCHEN SCHRAUBE;
2. DREHEN SIE DIE SCHRAUBE 1 / 4 UMDREHUNG IM UHRZEIGERSINN BIS SIE BEMERKEN, DASS DIE SCHRAUBE IM BEFESTIGUNGSPUNKT EINGEKLEMMT IST;
3. FÜR DIE DEMONTAGE FOLGEN SIE DEN HINWEISE UMGEKEHRT.

1. INSERTAR LA LLAVE ESPECIAL EN LA CABEZA DEL TORNILLO
2. DAR ¼ DE VUELTA EN EL SENTIDO HORARIO HASTA QUE LLEGUE AL TOPE Y SE VEA EL TORNILLO;
3. PARA DESMONTARLO PROCEDER EN LA DIRECCIÓN CONTRARIA;

### MONTAGGIO - ASSEMBLY - MONTAGE - MONTAGE - MONTAJE

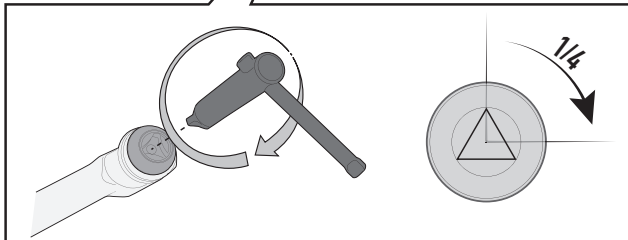
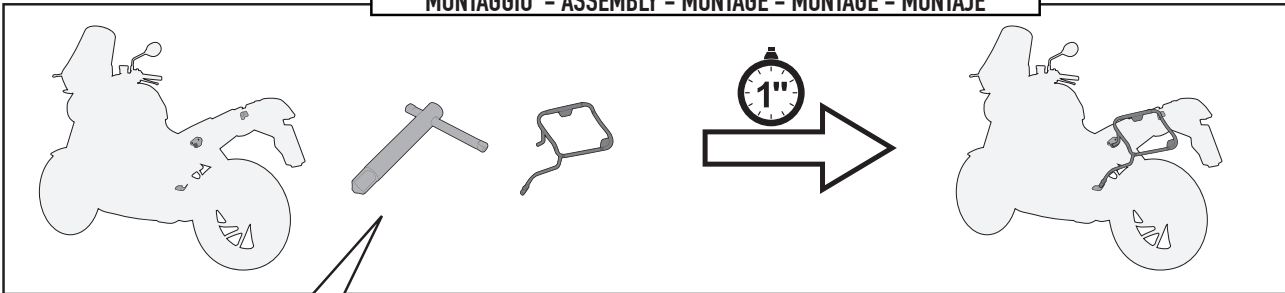

### SMONTAGGIO - DISASSEMBLY - DÉMONTAGE - DEMONTAGE - DESMONTAJE

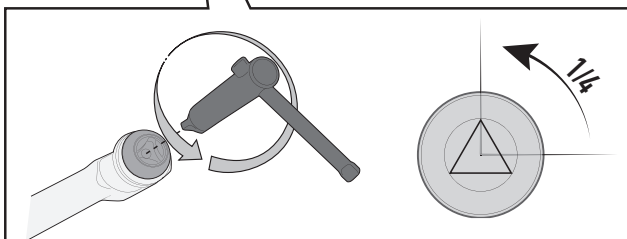
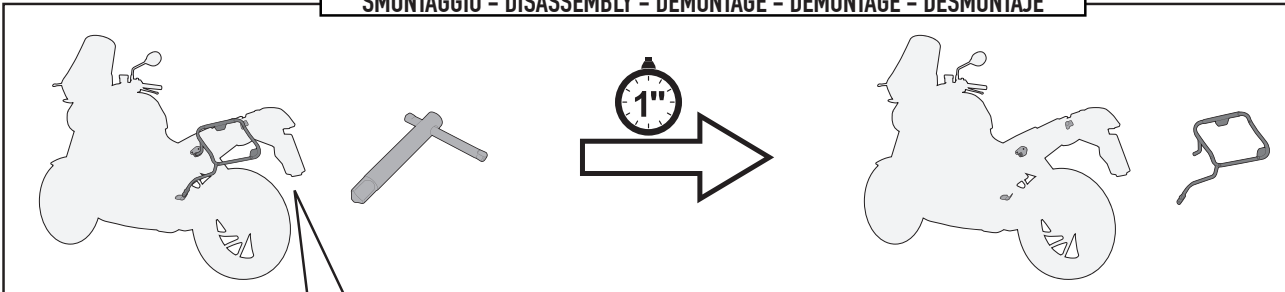

# PLXR2122 - KLXR2122

PORTAVALIGIE LATERALE SPECIFICO - SPECIFIC TUBULAR SIDE-CASE HOLDER - PORTE-VALISES LATÉRAUX SPÉCIFIQUE - SPEZIFISCHES STAHLROHR-SEITENTRAEGER  
PORTA MALETAS LATERALES ESPECÍFICO

## YAMAHA MT-09 TRACER (2015/2017)

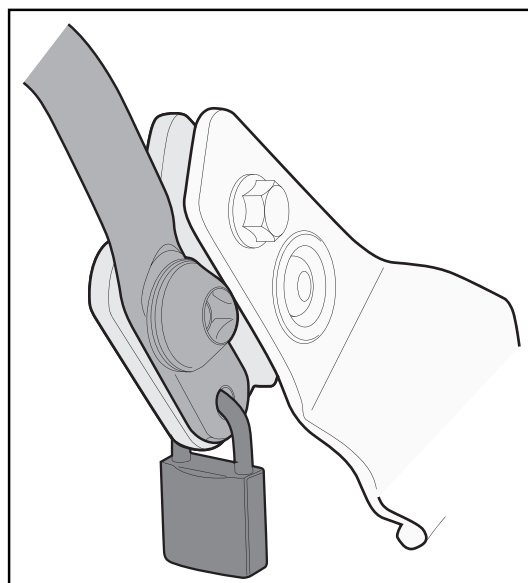
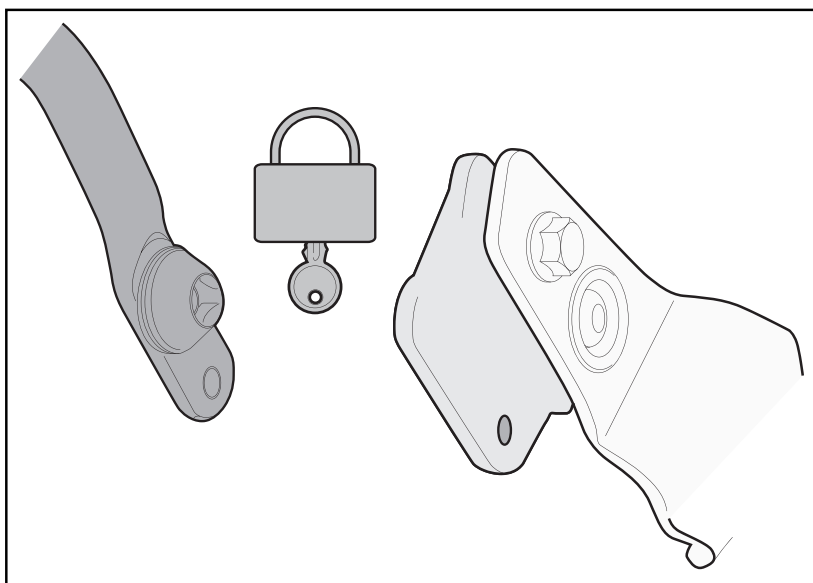
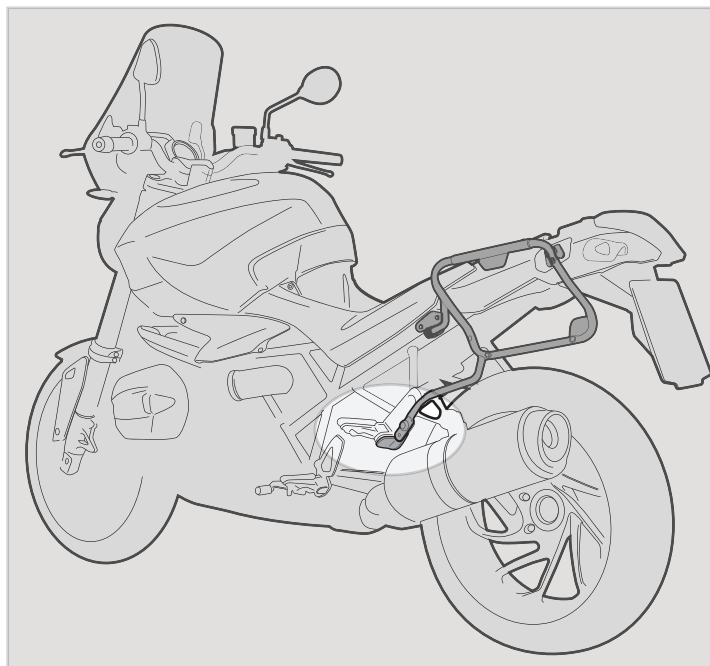

### FORO DI SICUREZZA

FORO PREDISPOSTO AD ASSICURARE IL PORTAVALIGIE LATERALE ALLA MOTO (CON UN LUCCHETTO PER ESEMPIO, NON INCLUSO).

### SECURITY HOLE

HOLE PLACEMENT IN ORDER TO INCREASE SECURITY OF THE TUBULAR SIDE-CASE HOLDER TO THE MOTORCYCLE (WITH A LOCK, FOR EXAMPLE, NOT INCLUDED).

### TROU DE SECURITE

TROU PREDISPOSE POUR ASSURER LE PORTE-VALISE LATERAL A LA MOTO (AVEC UN CADENAS PAR EXEMPLE, NON INCLUS).

### SICHERHEITSLÖCH

VORGESEHENES LOCH UM DEN SEITENKOFFER TRÄGER AN DEM FAHRZEUG ZU SICHERN (Z. B. MIT EINEM VORHÄNGESCHLOSS, NICHT ENTHALTEN);

### ORIFICIO DE SEGURIDAD

ESTE ORIFICIO ESTA CREADO PARA ASEGURAR EL PORTAEQUIPAJES LATERAL A LA MOTO (POR EJEMPLO CON UN CANDADO, QUE NO ESTÁ INCLUIDO).