











# RP2101

PARACOPPA - OIL CARTER PROTECTOR - SABOT MOTEUR - SPEZIFISCHER MOTORSCHUTZ - CUBRE CARTER

## YAMAHA XT1200Z SUPER TENERÉ (2010-2012)

N°	Descrizione	Caratteristiche	Codice	Quantità	
1	Paracoppa - Oil Carter Protector - Sabot Moteur - Spezifischer Motorschutz - Cubre Carter			1	
2	Supporto - Support - Support Halterung - Soporte		GL2207	1	
3	Supporto - Support - Support Halterung - Soporte		GL2201	1	
4	Vite - Screw Vis - Schraube Tornillo	TE M8x25	-	2	
5	Vite - Screw Vis - Schraube Tornillo	TE M8x20		2	
6	Vite - Screw Vis - Schraube Tornillo	TBEI M8X20		2	
7	Dado - Bolt - Ecrou Mutter - Tuerca	Auto Bloccante Flangiato M8		4	
8	Rondella - Washer Rondelle - Scheibe Arandela	Zigrinata Ø8	814RONZ	2	
9	Rondella - Washer Rondelle - Scheibe Arandela	Ø8x16	-	2	
10	Rondella - Washer Rondelle - Scheibe Arandela	Ø8x14		2	
11	Componenti Originali - Original Parts Parties Originales - Original Bauteile Componentes Originales				
12	Distanziale - Spacer Entretoise - Distanzstueck Distanciador	Ø10x9.8 foro 8.2mm	V044	2	



# RP2101

PARACOPPA - OIL CARTER PROTECTOR - SABOT MOTEUR - SPEZIFISCHER MOTORSCHUTZ - CUBRE CARTER

## YAMAHA XT1200Z SUPER TENERÉ (2010-2012)

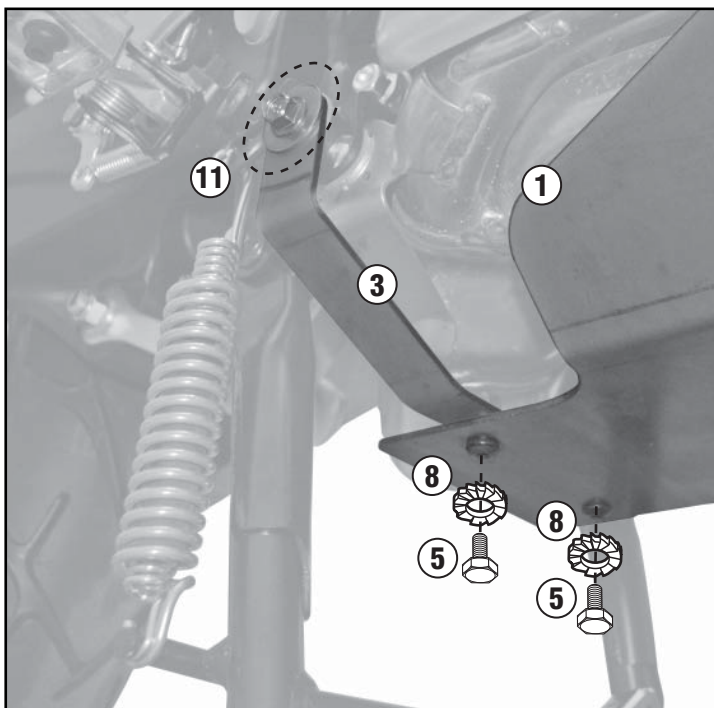
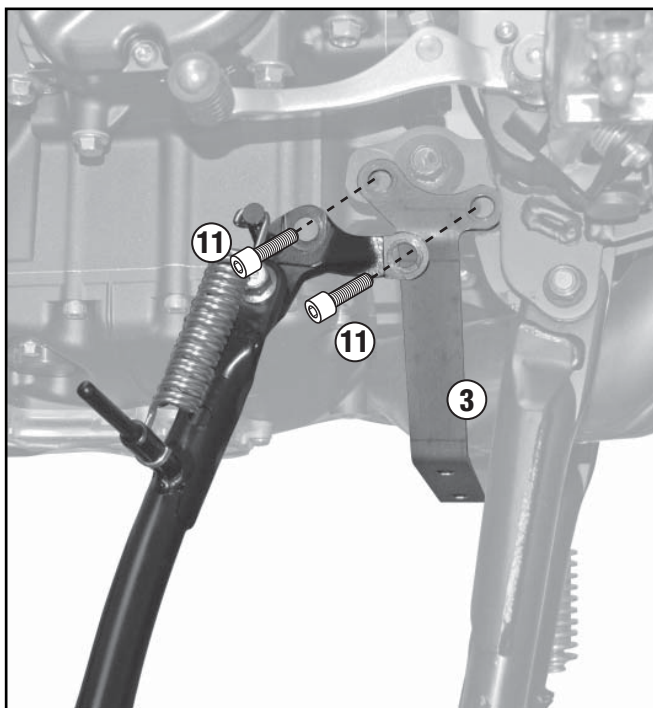
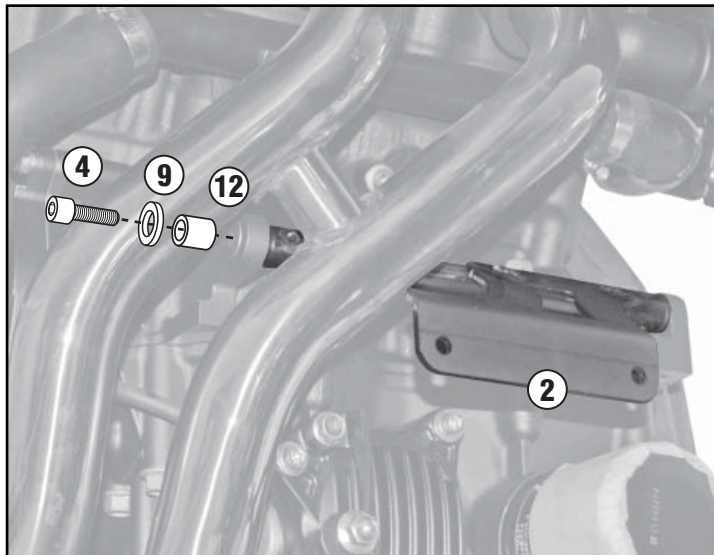
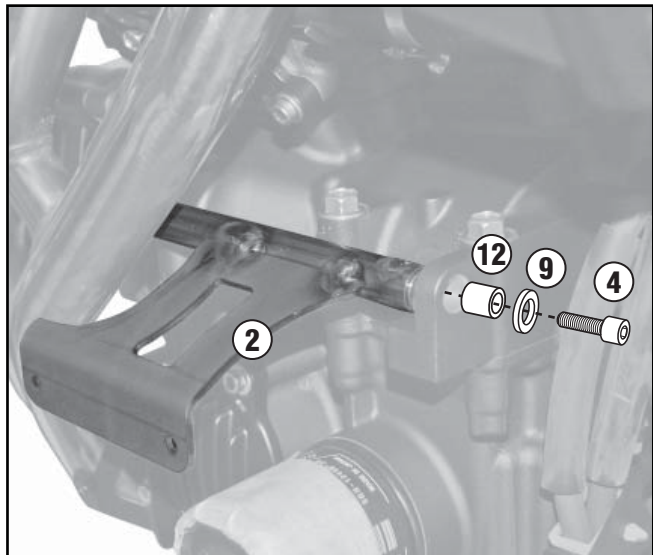

# RP2101

PARACOPPA - OIL CARTER PROTECTOR - SABOT MOTEUR - SPEZIFISCHER MOTORSCHUTZ - CUBRE CARTER

## YAMAHA XT1200Z SUPER TENERÉ (2010-2012)

