

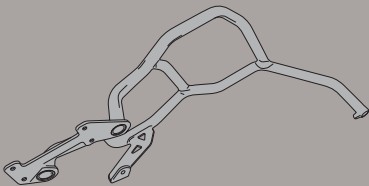





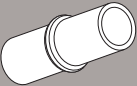

TN7703 - KN7703

PARAMOTORE SPECIFICO - SPECIFIC ENGINE GUARD - PARE-CARTER SPECIFIQUE SPEZIFISCHER STURZBÜGEL - DEFENSA DE MOTOR ESPECÍFICA - PARAMOTOR ESPECÍFICO



KTM 1190 ADVENTURE - 1190 ADVENTURE R (2013-2014) / 1050 ADVENTURE (2015)

N°	Descrizione	Caratteristiche	Codice	Quantità	
1	Paramotore - Engine Guard Pare-carter - Sturzbuegel Defensa De Moto - Paramotor	-	TN7703DXS TN7703SXS	2 (Dx,Sx)	
2	Supporto - Support - Support Halterung - Soporte - Apoio	-	GL2560S	4	
3	Supporto - Support - Support Halterung - Soporte - Apoio	-	Z2271	8	
4	Nipples	-	347TNG	1	
5	Vite - Screw Vis - Schraube Tornillo - Parafuso	TBEI M6x35	635TBEI	2	
6	Vite - Screw Vis - Schraube Tornillo - Parafuso	TCE M10x90	1090TCE	2	
7	Vite - Screw Vis - Schraube Tornillo - Parafuso	TBEI M6x55	655TBEI	8	
8	Rondella - Washer Rondelle - Scheibe Arandela - Arruela	Foro 6mm	6RON	4	
9	Rondella - Washer Rondelle - Scheibe Arandela - Arruela	Ø10	10RON	2	

TN7703 - KN7703

PARAMOTORE SPECIFICO - SPECIFIC ENGINE GUARD - PARE-CARTER SPECIFIQUE SPEZIFISCHER STURZBÜGEL - DEFENSA DE MOTOR ESPECÍFICA - PARAMOTOR ESPECÍFICO

KTM 1190 ADVENTURE - 1190 ADVENTURE R (2013-2014) / 1050 ADVENTURE (2015)

N°	Descrizione	Caratteristiche	Codice	Quantità	
10	Rondella - Washer Rondelle - Scheibe Arandela - Arruela	-	6RONSX	8	
11	Dado - Bolt - Ecrou Mutter - Tuerca - Porca	-	6DADIB	2	
12	Distanziale - Spacer Entretoise - Distanzstueck Distanciador - Espaçador	Ø18x25 Foro 10.5mm	C18L25F10,5T	2	
13	Distanziale - Spacer Entretoise - Distanzstueck Distanciador - Espaçador	Ø20x4 Foro 10.5mm	C20L4F10,5T	2	
14	Distanziale - Spacer Entretoise - Distanzstueck Distanciador - Espaçador	Ø22x6 Foro 10.5mm	C22L6F10,5T	2	
15	Componenti originali - Original parts Parties originales - Original bauteile Componentes originales - Componentes Originais	-	-	-	

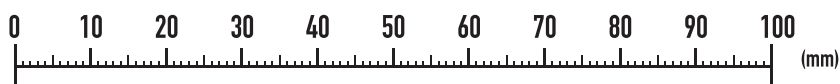
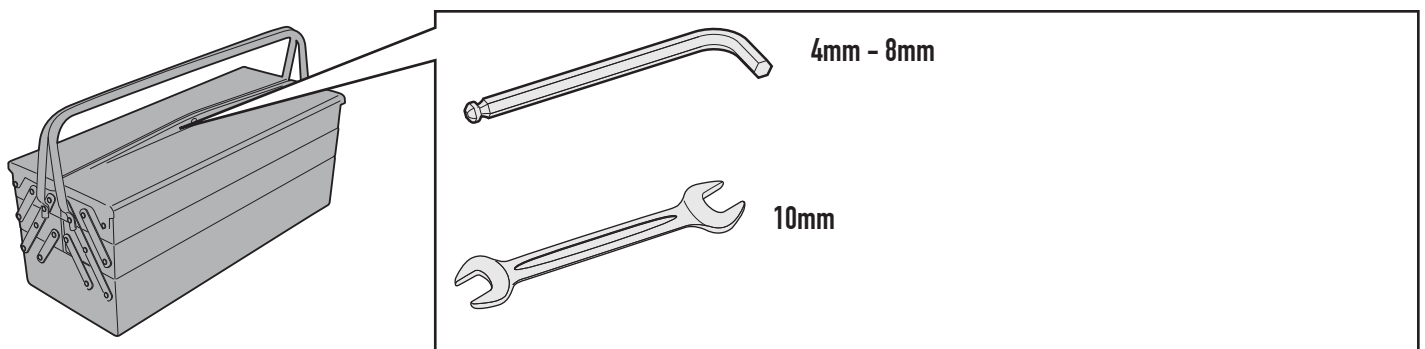

TN7703 - KN7703

PARAMOTORE SPECIFICO - SPECIFIC ENGINE GUARD - PARE-CARTER SPECIFIQUE SPEZIFISCHER STURZBÜGEL - DEFENSA DE MOTOR ESPECÍFICA - PARAMOTOR ESPECÍFICO

KTM 1190 ADVENTURE - 1190 ADVENTURE R (2013-2014) / 1050 ADVENTURE (2015)

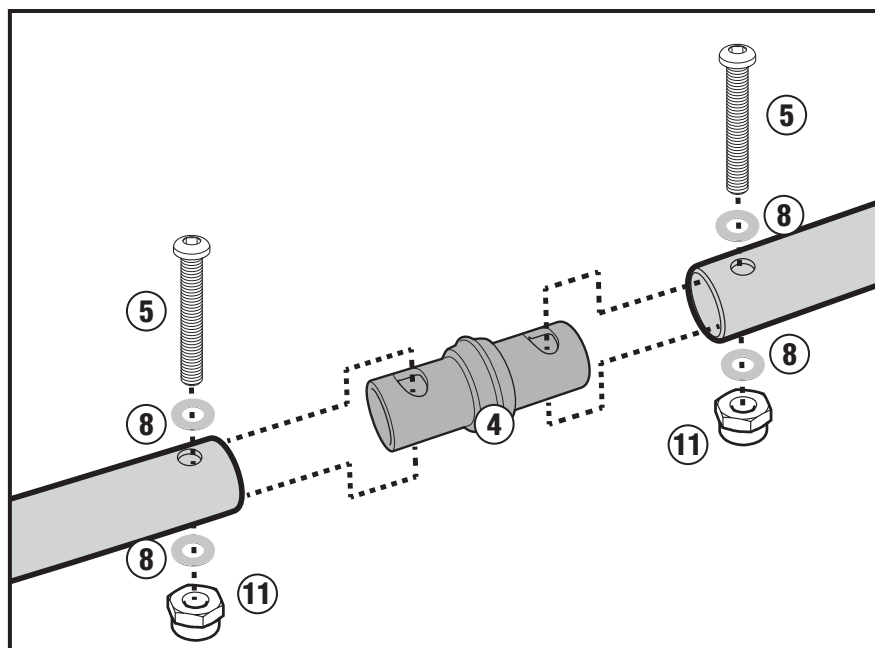
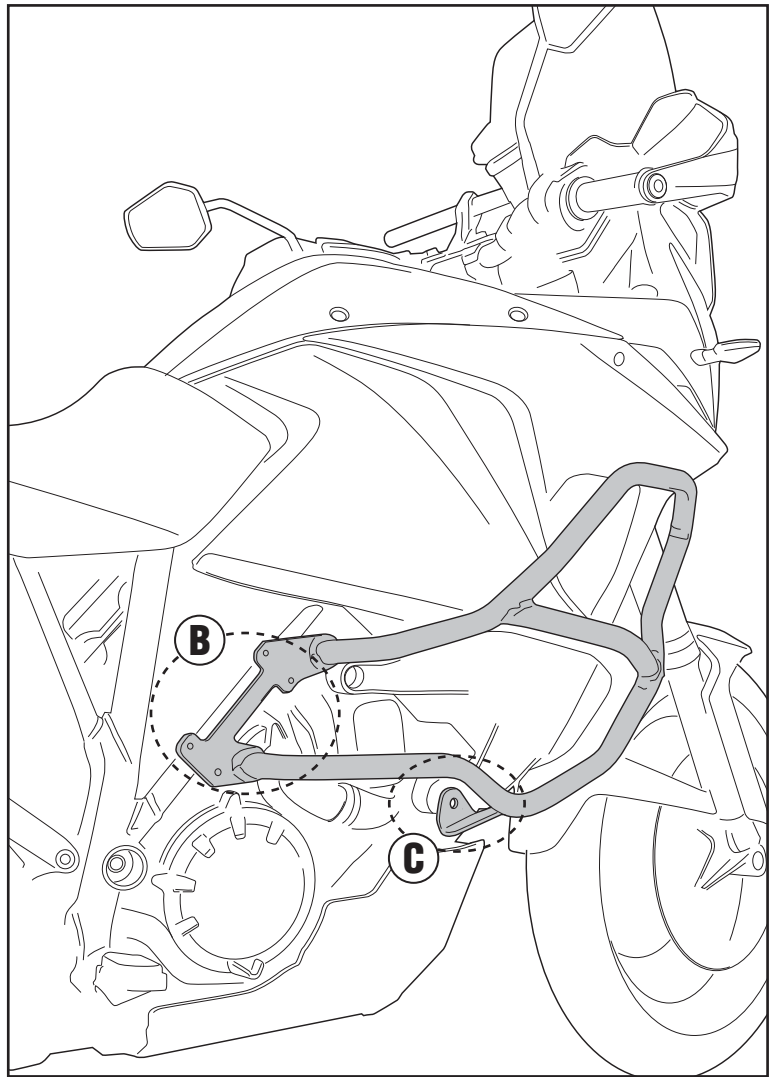
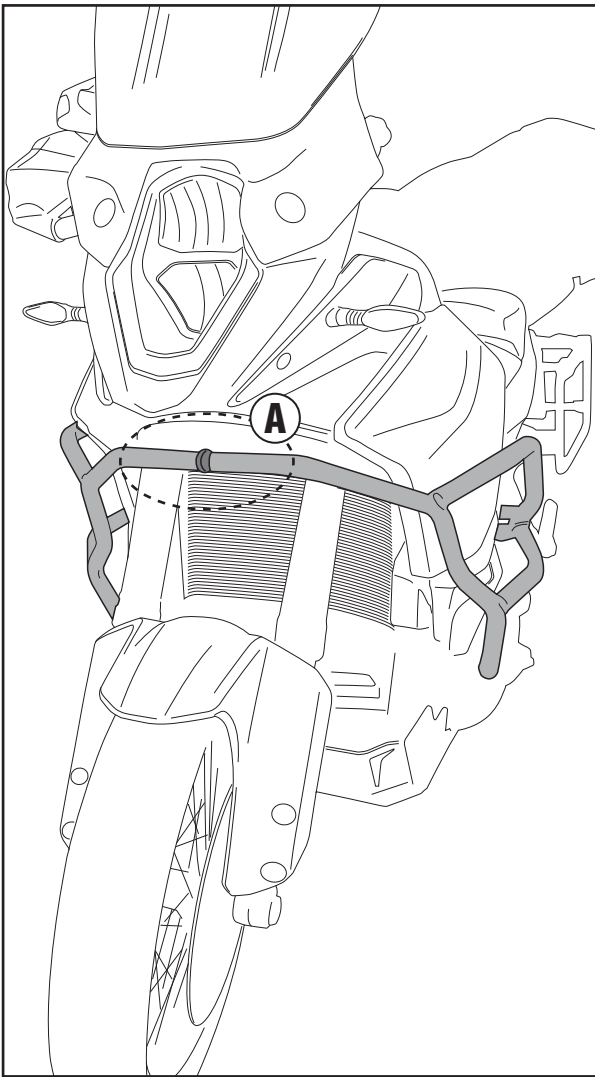

A

TN7703 - KN7703

PARAMOTORE SPECIFICO - SPECIFIC ENGINE GUARD - PARE-CARTER SPECIFIQUE SPEZIFISCHER STURZBÜGEL - DEFENSA DE MOTOR ESPECÍFICA - PARAMOTOR ESPECÍFICO

KTM 1190 ADVENTURE - 1190 ADVENTURE R (2013-2014) / 1050 ADVENTURE (2015)

