

365FZ-KZ365

MONORACK SPECIFICO - SPECIFIC MONORACK
MONORACK SPECIFIQUE - SPEZIFISCHES MONORACK - MONORACK ESPECÍFICO

YAMAHA FZ1 1000

'06-'09

ISTRUZIONI DI MONTAGGIO - MOUNTING INSTRUCTIONS
INSTRUCTIONS DE MONTAGE - BAUANLEITUNG - INSTRUCCIONES DE MONTAJE

© Copyright 140409AR-Rev00, 1/4

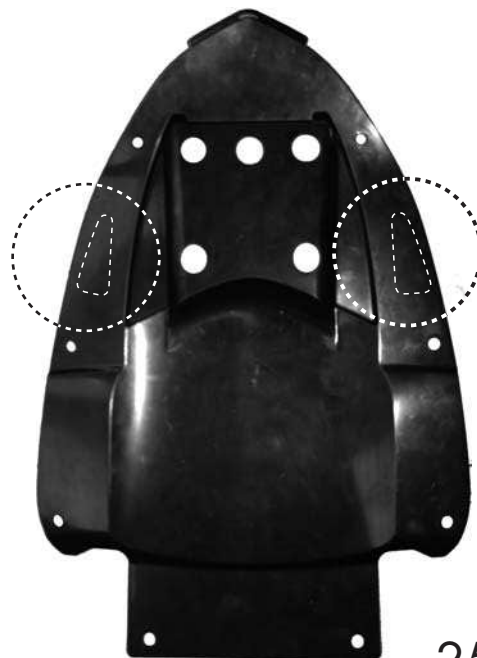
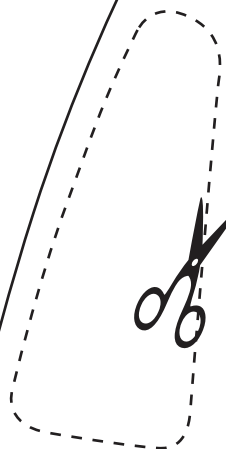

258,7 mm

PRIMA DI FORARE VERIFICARE CHE LA DIMA
CORRISPONDA ALLE MISURE INDICATE

BEFORE DRILLING HOLES CHECK THAT
MEASURES ON TEMPLATE CORRESPOND

AVANT DE PERCER CONTROLER QUE LE
GABARIT CORRESPOND AUX MESURES
INDIQUEE

BEVOR DER KOFFERDECKEL DURCHBOHRT
WIRD, PRÜFEN SIE DAß DIE SCHABLONE DEN
GEGEBENEN ABMESSUNGEN ENTSPRICHT

ANTES DE HACER LOS AGUJEROS
COMPROBAR LAS MEDIDAS DE LA PLANTILLA
CORRESPONIENTE

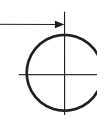
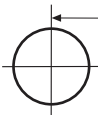
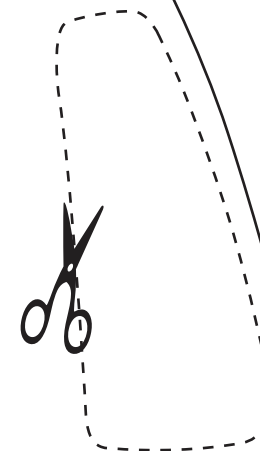

MONORACK SPECIFICO - SPECIFIC MONORACK
MONORACK SPECIFIQUE - SPEZIFISCHES MONORACK - MONORACK ESPECÍFICO

YAMAHA FZ1 1000

'06-'09

ISTRUZIONI DI MONTAGGIO - MOUNTING INSTRUCTIONS
INSTRUCTIONS DE MONTAGE - BAUANLEITUNG - INSTRUCCIONES DE MONTAJE

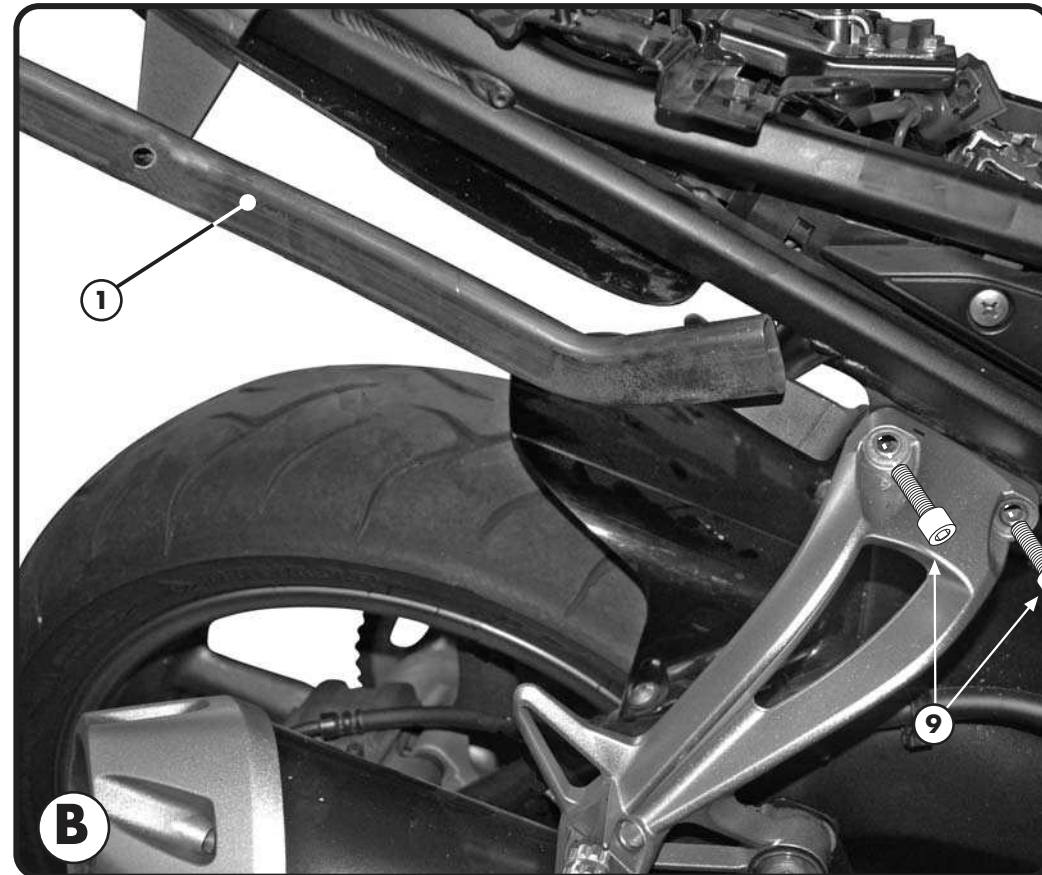
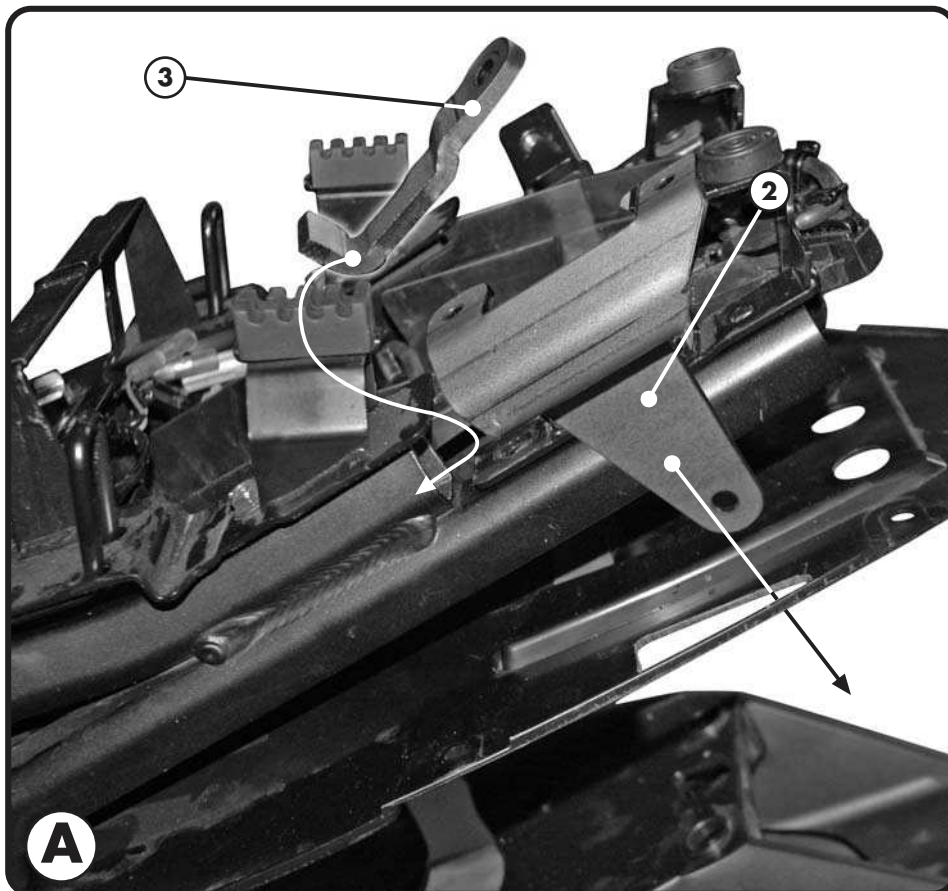
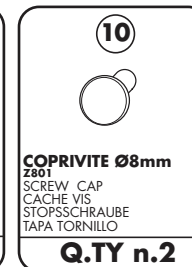
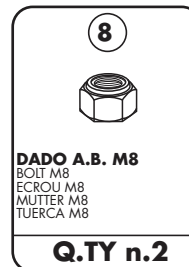
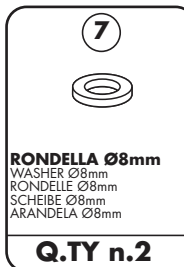
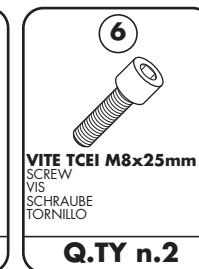
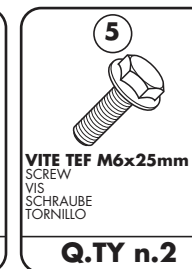
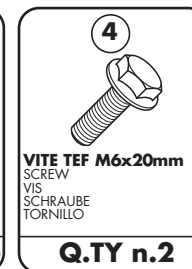

MONORACK SPECIFICO - SPECIFIC MONORACK
 MONORACK SPECIFIQUE - SPEZIFISCHES MONORACK - MONORACK ESPECÍFICO

YAMAHA FZ1 1000

'06-'09

ISTRUZIONI DI MONTAGGIO - MOUNTING INSTRUCTIONS
 INSTRUCCIONES DE MONTAJE - BAUANLEITUNG - INSTRUCCIONES DE MONTAJE

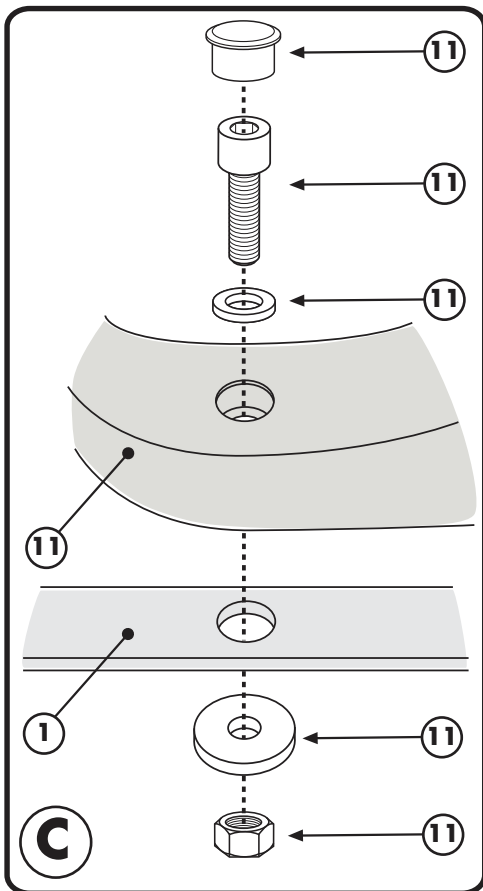

D

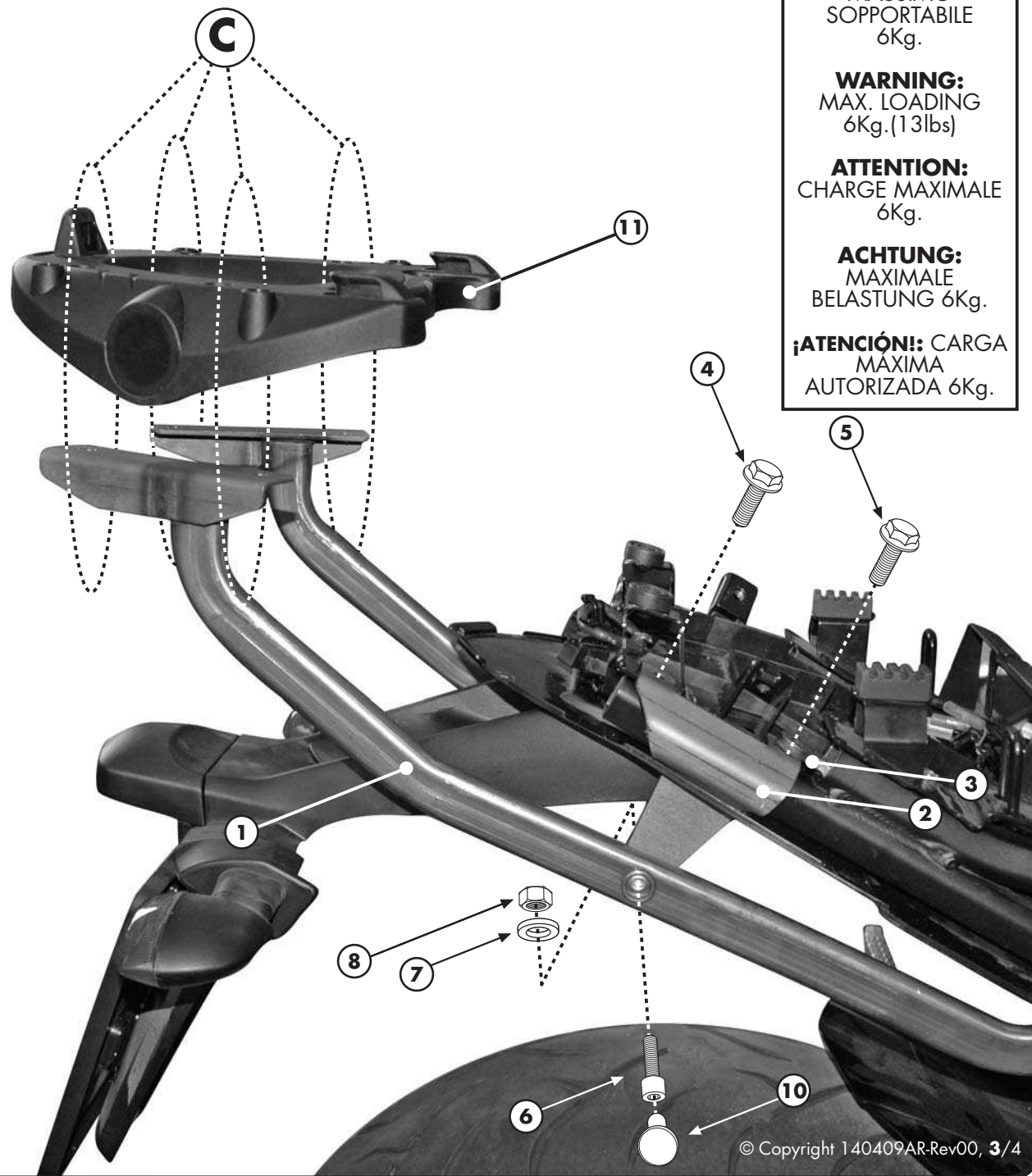

ATTENZIONE: PESO
 MASSIMO
 SOPPORTABILE
 6Kg.

WARNING:
 MAX. LOADING
 6Kg. (13lbs)

ATTENTION:
 CHARGE MAXIMALE
 6Kg.

ACHTUNG:
 MAXIMALE
 BELASTUNG 6Kg.

¡ATENCIÓN! CARGA
 MÁXIMA
 AUTORIZADA 6Kg.

MONORACK SPECIFICO - SPECIFIC MONORACK
MONORACK SPECIFIQUE - SPEZIFISCHES MONORACK - MONORACK ESPECÍFICO

YAMAHA FZ1 1000

'06-'09

ISTRUZIONI DI MONTAGGIO - MOUNTING INSTRUCTIONS
INSTRUCTIONS DE MONTAGE - BAUANLEITUNG - INSTRUCCIONES DE MONTAJE

I ISTRUZIONI DI MONTAGGIO

1. PRIMA DI PROCEDERE AL MONTAGGIO DEL MONORACK, SMONTARE E FORARE IL SOTTOCODA DELLA MOTO UTILIZZANDO LA DIMA RIPORTATA A PAGINA 1;
2. RIMONTARE IL CODONE ORIGINALE;
3. FISSARE I SUPPORTI N°1 ALLE PEDALINE DEL PASSEGGERO COME INDICATO IN FIGURA B ED AI SUPPORTI N°2 COME INDICATO IN FIGURA D;
4. ULTIMARE IL MONTAGGIO VERIFICANDO CHE TUTTE LE VITI SIANO SERRATE BENE (VITI M6=9,6Nm - VITI M8=23Nm).

GB MOUNTING INSTRUCTIONS

1. BEFORE PROCEEDING WITH THE MONORACK MOUNTING, DISASSEMBLE AND PIERCE THE MOTORCYCLE UNDER-TRAY USING THE ILLUSTRATION ON PAGE 1;
2. SET THE ORIGINAL GREAT-QUEUE;
3. FIX THE SUPPORTS N°1 TO THE PASSENGER FOOT-RESTS AS YOU CAN SEE FROM PICTURE B AND THE SUPPORTS N°2 AS YOU CAN SEE FROM PICTURE D;
4. CHECK THAT ALL THE SCREWS ARE WELL TIGHTENED (SCREWS M6=9,6Nm - SCREWS).

F INSTRUCTIONS DE MONTAGE

1. AVANT DE PROCEDER AU MONTAGE DU MONORACK, DEMONTER ET PERCER LA SOUS-QUEUE DE LA MOTO EN UTILISANT LE GABARIT DE PERCAGE DE LA PAGE 1;
2. MONTER LA GRAND-QUEUE D'ORIGINE;
3. FIXER LES SUPPORTS N°1 AUX REPOSE-PIEDS PASSAGER COMME INDIQUE EN PHOTO B ET AUX SUPPORTS N°2 COMME INDIQUE EN PHOTO D;
4. TERMINER LE MONTAGE EN CONTROLANT LE BON SERRAGE DE TOUTES LES VIS (VIS M6=9,6Nm - VIS M8=23Nm).

D BAUANLEITUNG

1. BEVOR SIE DAS MONORACK MONTIEREN, BAUEN SIE DIE HECKVERKLEIDUNG DES FAHRZEUGES AB UND BOHREN SIE MIT HILFE DER SCHABLONE AUF SEITE 1 DIE VORGEGEHENEN LÖCHER;
2. MONTIEREN SIE DAS ORIGINALHECK;
3. MONTIEREN SIE DIE HALTERUNGEN NR. 1 AN DEN BEIFAHRE-FUßRASTERN WIE IN BILD B GEZEIGT UND AN DEN HALTERUNGEN NR. 2 WIE IM BILD D GEZEIGT;
4. ZULETZT ÜBERPRÜFEN SIE DASS ALLE SCHRAUBEN (SCHRAUBEN M6=9,6NM - SCHRAUBEN M8=23NM) FESTGEZOGEN WURDEN.

ES INSTRUCCIONES DE MONTAJE

1. ANTES DE PROCEDER AL MONTAJE DEL MONORACK, DESMONTAR Y AGUJEREAR EL COLÍN DE LA MOTO USANDO LA PLANTILLA IMPRESA EN PAG 1;
2. VOLVER A MONTAR EL COLÍN ORIGINAL
3. FIJAR LOS SOPORTES N.1 A LAS ESTRIBERAS DEL PASAJERO COMO SE INDICA EN LA FOTO B Y A LOS SOPORTES N. 2 COMO SE INDICA EN LA FOTO D;
4. TERMINAR EL MONTAJE VERIFICANDO QUE TODOS LOS TORNILLOS ESTÉN BIEN APRETADOS (TORNILLOS M6=9,6NM - TORNILLOS M8=23NM).