

ATTACCHI SPECIFICI PER - SPECIFIC FITTING KIT FOR
 KIT DE MONTAGE SPECIFIQUE POUR - SPEZIFISCHER MONTAGEKIT FÜR
 ANCLAJE ESPECIFICO PARA

YAMAHA CIGNUS X 125 2007

ISTRUZIONI DI MONTAGGIO - MOUNTING INSTRUCTIONS
 INSTRUCTIONS DE MONTAGE - BAUANLEITUNG - INSTRUCCIONES DE MONTAJE

1



SUPPORTO
 SUPPORT
 SUPPORT
 HALTERUNG
 SOPORTE

Q.TY n.2(Dx-Sx)

2



PIASTRINA
 LITTLE PLATE
 PETITE PLAQUE
 PLAETTCHEN
 PLAQUETA

Q.TY n.2(Dx-Sx)

3

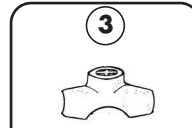

FASCETTA A "T"
 Z870N
 "T" CLAMP
 COLLIER A "T"
 "T" SCHELLE
 ABRAZADERA A "T"

Q.TY n.4

4



BOCCOLA DI RITENZIONE
 VETRO z871N
 PLASTIC BUSH
 DOUILLE PLASTIQUE
 PLASTIK BÜCHSE
 CASQUILLO

Q.TY n.4

5

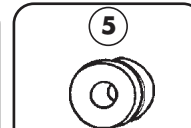

GOMMINO Z268
 Z268 FAIRLEADER
 CHAUMARD Z268
 GUMMI Z268
 GOMA Z268

Q.TY n.4

6

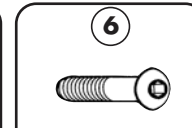

VITE TBEI M6x25 nera
 SCREW M6x25 black
 VIS M6x25 noire
 SCHRAUBE M6x25 schwarz
 TORNILLO M6x25 negra

Q.TY n.4

7

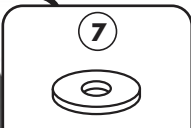

RONDELLA Ø13,5x25
SPESSORE 2mm
 WASHER Ø13,5x25mm
 RONDELLE Ø13,5x25mm
 SCHEIBE Ø13,5x25mm
 ARANDELA Ø13,5x25mm

Q.TY n.2

8



RONDELLA IN GOMMA
Ø15X25 SPESSORE 4
 RUBBER WASHER
 RONDELLE EN GOMME
 GUMMISCHIBE
 ARANDELA DE GOMA

Q.TY n.3

9



RONDELLA IN GOMMA
Ø16X33 SPESSORE 1
 RUBBER WASHER
 RONDELLE EN GOMME
 GUMMISCHIBE
 ARANDELA DE GOMA

Q.TY n.2

10

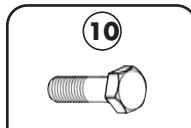

VITE TE M8x55mm
 SCREW M8x55mm
 VIS M8x55mm
 SCHRAUBE M8x55mm
 TORNILLO M8x55mm

Q.TY n.2

11

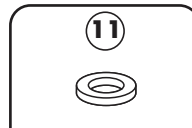

RONDELLA Ø8mm
 WASHER Ø8mm
 RONDELLE Ø8mm
 SCHEIBE Ø8mm
 ARANDELA Ø8mm

Q.TY n.2

12



COMPONENTI ORIGINALI
 ORIGINAL PARTS
 PARTIES ORIGINALES
 ORIGINAL BAUTEILE
 COMPONENTES ORIGINALES

Q.TY n.-

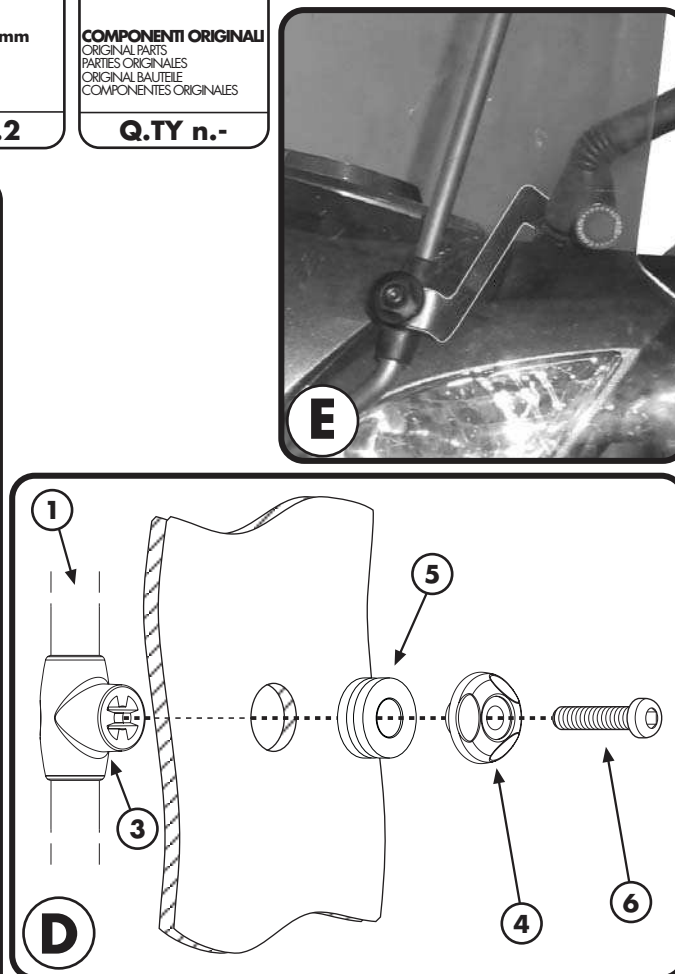
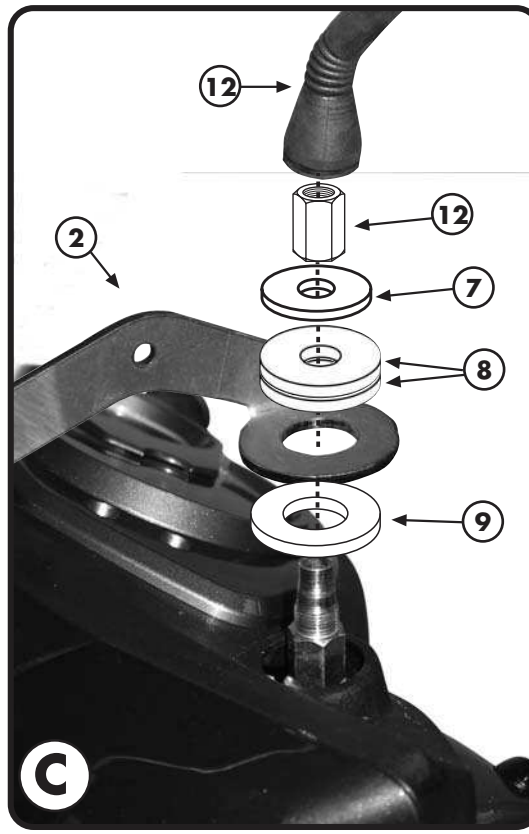
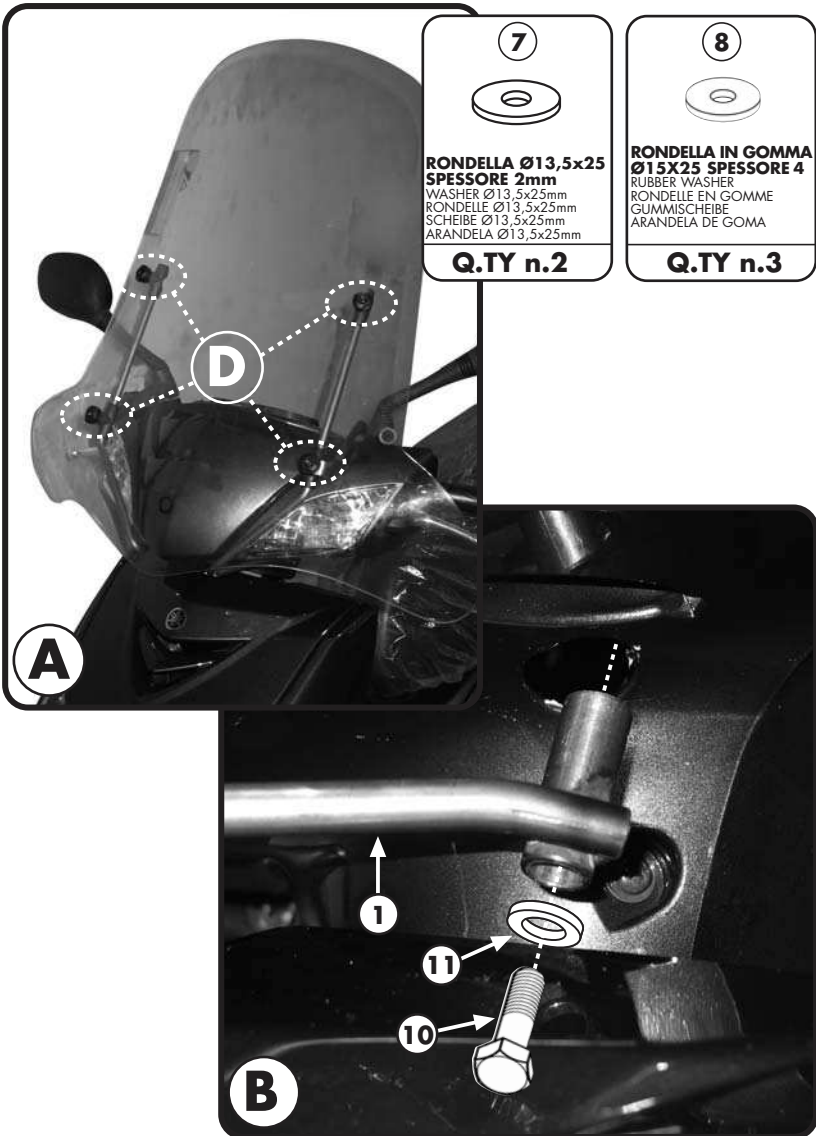

**ATTACCHI SPECIFICI PER - SPECIFIC FITTING KIT FOR
KIT DE MONTAGE SPECIFIQUE POUR - SPEZIFISCHER MONTAGEKIT FÜR
ANCLAJE ESPECIFICO PARA**

YAMAHA CIGNUS X 125 2007

ISTRUZIONI DI MONTAGGIO - MOUNTING INSTRUCTIONS
INSTRUCTIONS DE MONTAGE - BAUANLEITUNG - INSTRUCCIONES DE MONTAJE

I ISTRUZIONI DI MONTAGGIO

1. RIMUOVERE I TAPPI COPRIFORO PRESENTI SULLA PARTE INFERIORE DELLA CARENATURA DEL MANUBRIO INTERESSATE NEL MONTAGGIO DELLE ASTE SUPPORTO N°1, FOTOGRAFIA B;
2. QUINDI ESEGUIRE IL MONTAGGIO INDICATO IN FOTOGRAFIA B E C FACENDO ATTENZIONE CHE NEL MONTAGGIO SUL LATO DESTRO LA RONDELLA N°8 VA UTILIZZATA IN QUANTITÀ 1 PEZZO MENTRE SUL LATO SINISTRO VA UTILIZZATA IN QUANTITÀ 2 PEZZI;
3. MONTARE IL PARABREZZA (NON INCLUSO), IMMAGINE D;
4. ULTIMARE IL MONTAGGIO CONTROLLANDO CHE TUTTE LE VITI SIANO SERRATE BENE.

GB MOUNTING INSTRUCTIONS

1. REMOVE THE HOLE CAPS PLACED IN THE LOWER PART OF THE FAIRING OF THE HANDLEBAR, SO AS TO ENABLE THE FIXING OF THE SUPPORT BARS N°1, PICTURE B;
2. FOLLOW THE MOUNTING PROCEDURE INDICATED IN THE PICTURES B AND C PAYING ATTENTION THAT YOU SHOULD USE 1 PC OF THE RUBBER WASHER N°1 FOR THE RIGHT SIDE AND 2 PCS OF THE SAME FOR THE LEFT SIDE;
3. MOUNT THE WIND-SCREEN (NOT INCLUDED) AS SHOWN IN PICTURE D;
4. LASTLY CHECK THAT ALL SCREWS HAVE BEEN TIGHTENED.

F INSTRUCTIONS DE MONTAGE

1. ENLEVER LES CACHES SE TROUVANT SUR LA PARTIE INFÉRIEURE DU CARENAGE DU GUIDON, CONCERNES PAR LE MONTAGE DES SUPPORTS N.1, PHOTO B ;
2. PROCÉDER AU MONTAGE INDIQUE EN PHOTO B ET C FAIRE ATTENTION A NE METTRE QU'UNE RONDELLE N°8 DU CÔTÉ DROIT ET DEUX DU CÔTÉ GAUCHE ;
3. MONTER LE PARE-BRISE (NON INCLUS) , PHOTO D ;
4. TERMINER LE MONTAGE EN CONTROLANT LE BON SERRAGE DE TOUTES LES VIS.

D BAUANLEITUNG

1. ENTFERNEN SIE DIE LOCHABDECKUNGEN AUS DEM UNTEREN TEIL DER LENKERVERKLEIDUNG, UM DIE MONTAGE DER HALTERUNGSTANGEN NR. 1 ZU ERMO'F6GLICHEN, BILD B;
2. FU'FCHREN SIE DIE MONTAGE DER BILDER B UND C DURCH, PASSEN SIE AUF, DASS BEI DER MONTAGE DER RECHTEN SEITE 1 STK. DER GUMMISCHEIBE NR. 8 VERWENDET WIRD, FU'FCR DIE LINKE SEITE BRAUCHEN SIE DAGEGEN 2 STK.
3. MONTIEREN SIE DAS WINDSCHILD (NICHT VORHANDEN), BILD D;
4. ZULETZT U'FCBERPRU'FCFEN SIE, DASS ALLE SCHRAUBEN FESTGEZOGEN WURDEN.

ES

INSTRUCCIONES DE MONTAJE

1. QUITAR LOS TAPONES DE LOS TORNILLOS QUE SE ENCUENTRAN EN LA PARTE INFERIOR DEL CARENADO DEL MANILLAR . DESPUÉS MONTAR LOS ANCLAJES SOPORTE N°1 FOTOGRAFIA B
2. EFECTUAR EL MONTAJE INDICADO EN LAS FOTOGRAFÍAS "B" Y "C" TENIENDO CUIDADO EN EL MONTAJE. AL LADO DERECHO SE USA SOLO UNA ARANDELA N° 8 MIENTRAS QUE AL LADO IZQUIERDO SE UTILIZAN 2 ARANDELAS;
3. MONTAR EL PARABRISAS (NO INCLUIDO) IMAGEN "D"
4. TERMINAR EL MONTAJE VERIFICANDO QUE TODOS LOS TORNILLOS ESTEN BIEN CERRADOS.