







1109FZ - KZ1109

MONORACK SPECIFICO - SPECIFIC MONORACK - MONORACK SPECIFIQUE - SPEZIFISCHES MONORACK - MONORACK ESPECÍFICO

HONDA INTEGRA 700 (2012)

N°	Descrizione	Caratteristiche	Codice	Quantità	
1	Supporto - Blinker Support Support - Halter - Soporte	-	-	2 (Dx/Sx)	
2	Supporto - Blinker Support Support - Halter - Soporte	-	GL2089	2 (Dx/Sx)	
3	Supporto - Blinker Support Support - Halter - Soporte	-	GL2090	2 (Dx/Sx)	
4	Vite - Screw Vis - Schraube Tornillo	TCEI M8x25	-	4	
5	Vite - Screw Vis - Schraube Tornillo	TCEI M8x30	-	4	
6	Dado - Bolt - Ecrou Mutter - Tuerca	Auto Bloccante Flangiato M8	-	4	
9	Coprivite - Screw Cap Cache Vis - Stopsschraube Tapa Tornillo	-	Z801	4	
10	Particolari Inclusi Nel Kit Viteria Della Piastra Components Included In The Fitting Kit Of The Plate Pièces Incluses Dans Le Kit De Vis De La Platine Die Einzelnen Teile Sind Bei Montagekit Der Platte Enthalten Despieces Incluidos En El Kit De Anclajes De La Parrilla				
11	Componenti Originali Original Parts Parties Originales Original Bauteile Componentes Originales				
12	Protezione Adesiva - Adhesive Protection Protection Adhesive - Schutzkleber Protección Adhesiva	-	Z1763	1x50mm cut in 4 pcs	



1109FZ - KZ1109

MONORACK SPECIFICO - SPECIFIC MONORACK - MONORACK SPECIFIQUE - SPEZIFISCHES MONORACK - MONORACK ESPECÍFICO

HONDA INTEGRA 700 (2012)

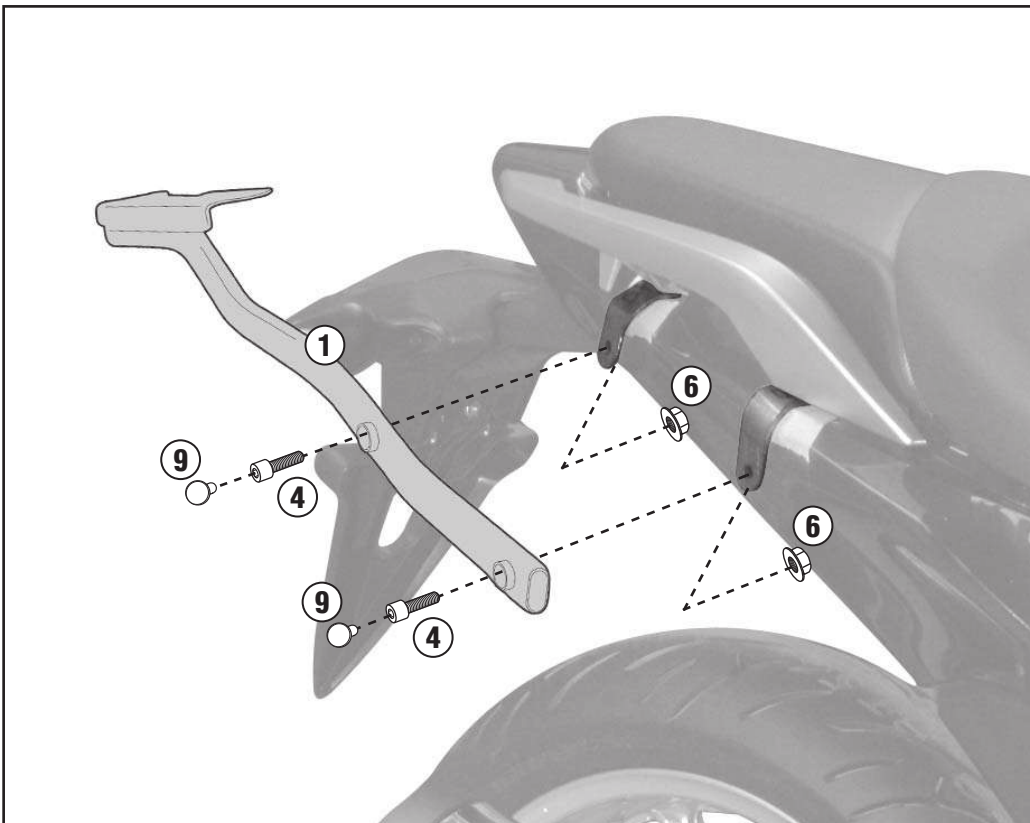
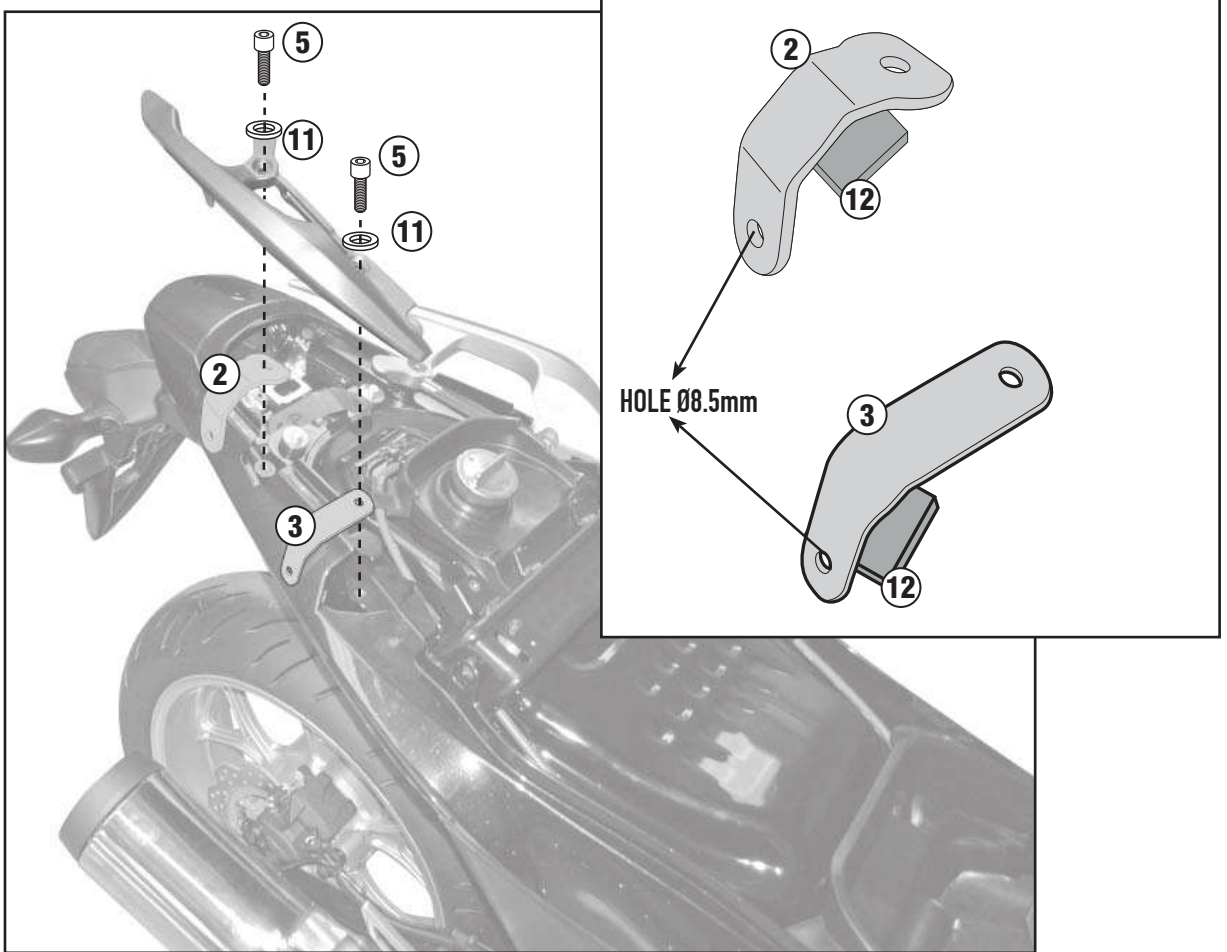

1109FZ - KZ1109

MONORACK SPECIFICO - SPECIFIC MONORACK - MONORACK SPECIFIQUE - SPEZIFISCHES MONORACK - MONORACK ESPECÍFICO

HONDA INTEGRA 700 (2012)

