

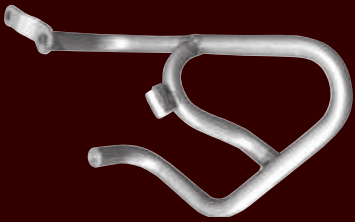



TN1111 - KN1111

PARAMOTORE SPECIFICO - SPECIFIC ENGINE GUARD - PARE-CARTER SPECIFIQUE SPEZIFISCHER STURZBÜGEL - DEFENSA DE MOTOR ESPECÍFICA

HONDA NC700X (2012)

N°	Descrizione	Caratteristiche	Codice	Quantità	
1	Paramotore - Engine Guard Pare-carter - Sturzbuegel Defensa De Moto	-	-	2 (Dx,Sx)	
2	Supporto - Support Support - Halter - Soporte	-	GL2108	2 (Dx,Sx)	
3	Supporto - Support Support - Halter - Soporte	-	-	2 (Dx,Sx)	
4	Vite - Screw Vis - Schraube Tornillo	TEF M8x20mm	-	2	
5	Vite - Screw Vis - Schraube Tornillo	TEF M6x16	-	4	
6	Protezione Adesiva - Adhesive Protection Protection Adhesive - Schutzkleber Protección Adhesiva	(35x100)mm	Z2086	2	
7	Componenti originali - Original parts Parties originales - Original bauteile Componentes originales	-	-	-	

TN1111 - KN1111

PARAMOTORE SPECIFICO - SPECIFIC ENGINE GUARD - PARE-CARTER SPECIFIQUE SPEZIFISCHER STURZBÜGEL - DEFENSA DE MOTOR ESPECÍFICA

HONDA NC700X (2012)

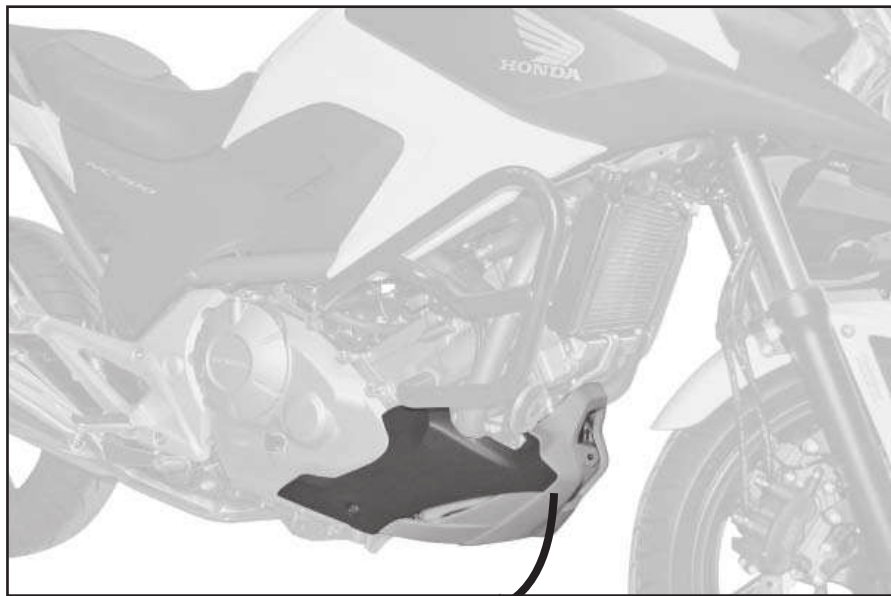

TOGLIERE
REMOVE
ENLEVER
ENTFERNEN
QUITAR

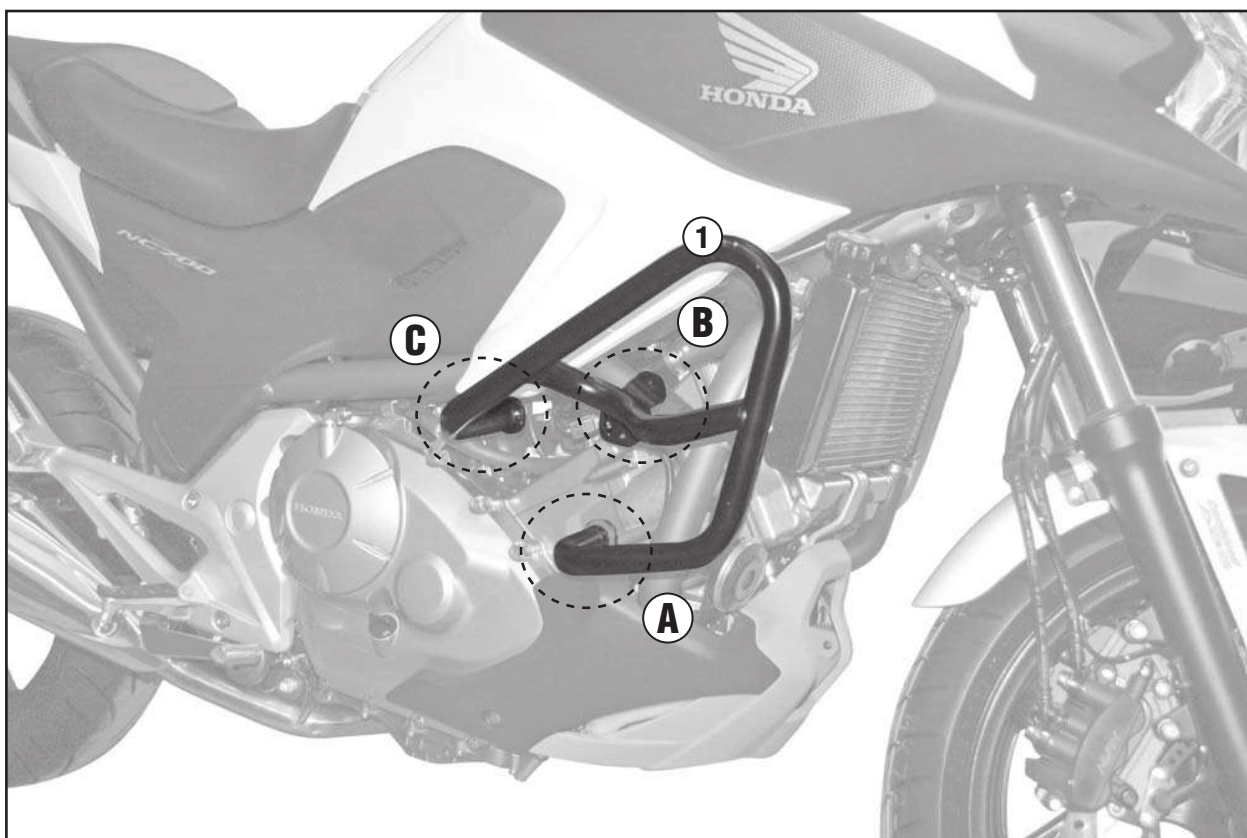

TN1111 - KN1111

PARAMOTORE SPECIFICO - SPECIFIC ENGINE GUARD - PARE-CARTER SPECIFIQUE SPEZIFISCHER STURZBÜGEL - DEFENSA DE MOTOR ESPECÍFICA

HONDA NC700X (2012)

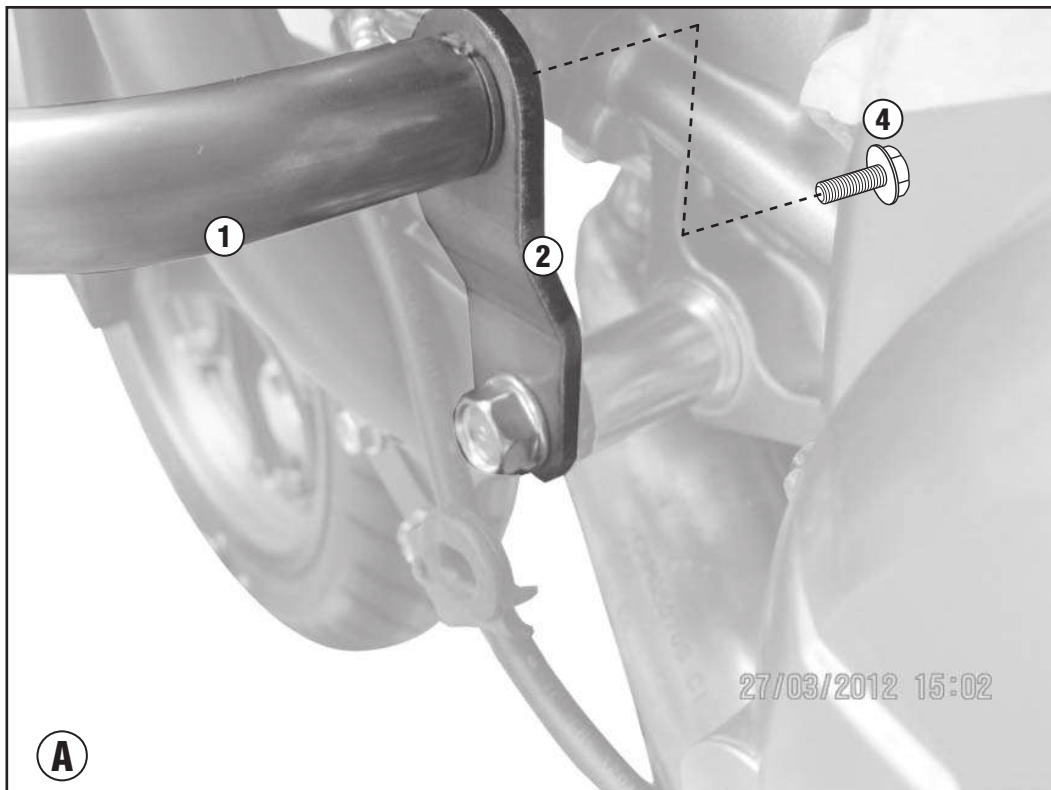
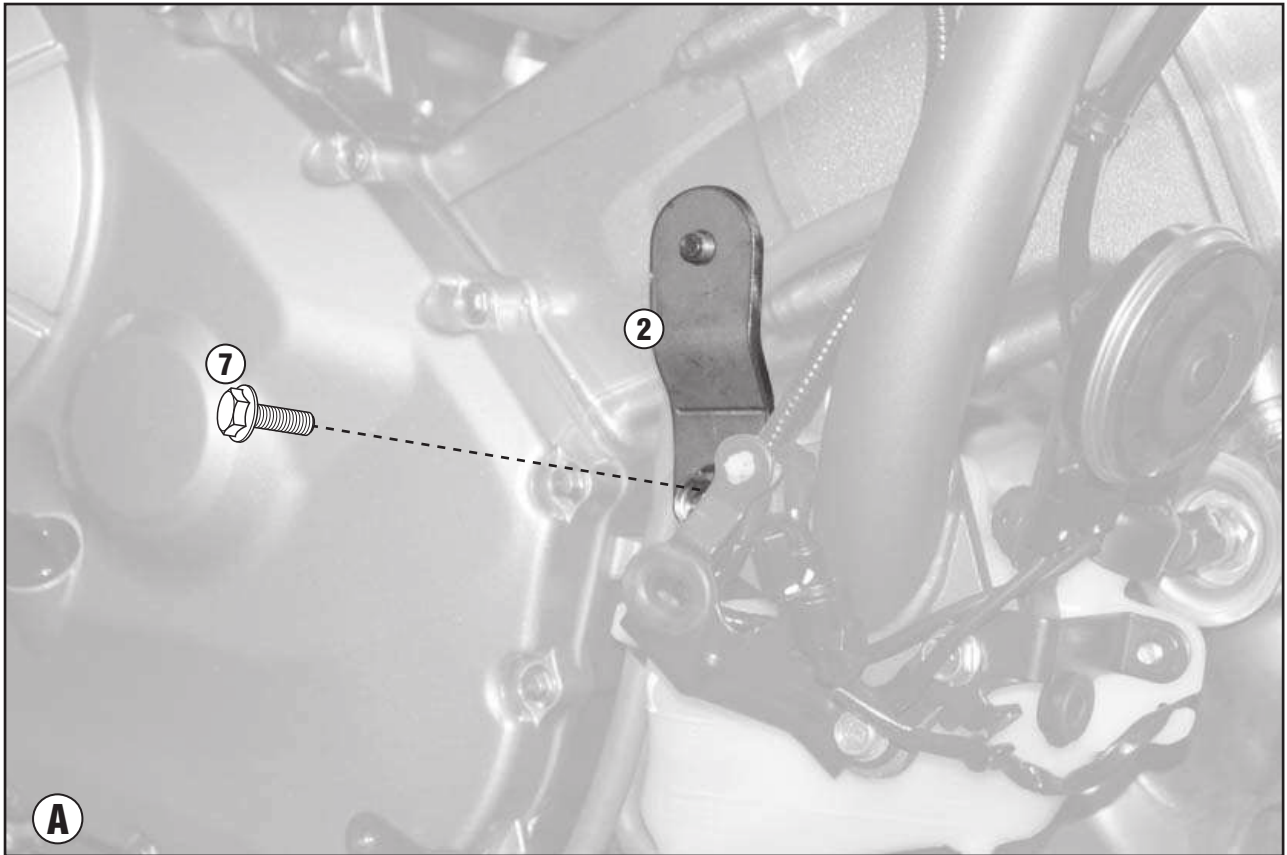

TN1111 - KN1111

PARAMOTORE SPECIFICO - SPECIFIC ENGINE GUARD - PARE-CARTER SPECIFIQUE SPEZIFISCHER STURZBÜGEL - DEFENSA DE MOTOR ESPECÍFICA

HONDA NC700X (2012)

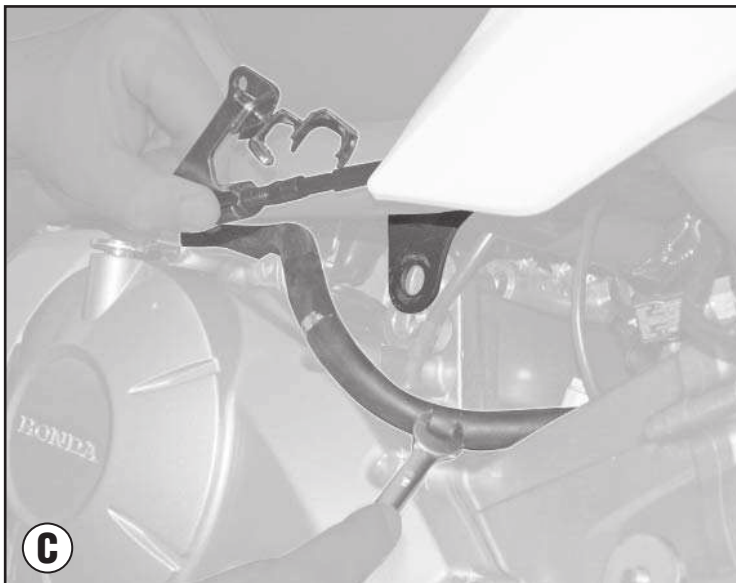
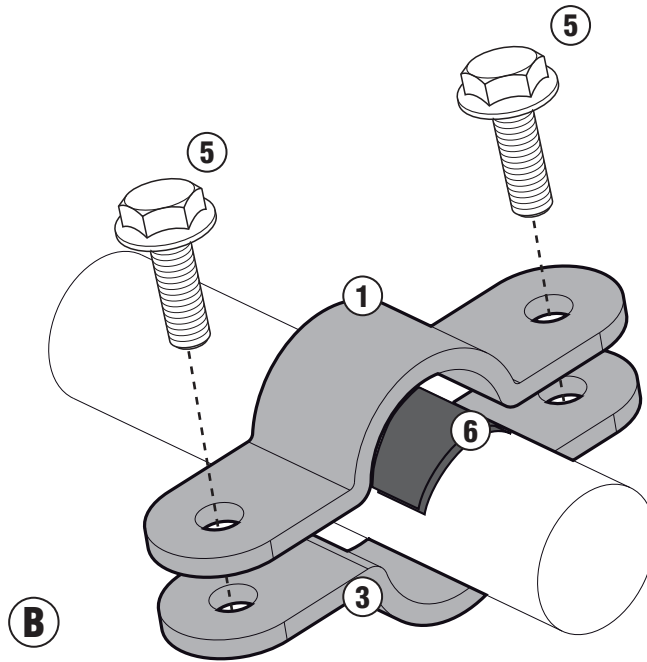

Smontare prima di svitare la vite originale
Remove before unscrewing the original screw
Retirer avant de dévisser la vis d'origine
Entfernen Sie vor dem Herausdrehen der Schraube original
Retirar antes de desenroscar el tornillo original

