

PARACOPPA SPECIFICO - OIL CARTER PROTECTION
 SABOT MOTEUR SPECIFIQUE - SPEZIFISCHER MOTORSCHUTZ - CUBRE CARTER ESPECIFICO

SUZUKI DL650 V-STROM I2

2011 - 2012

ISTRUZIONI DI MONTAGGIO - MOUNTING INSTRUCTIONS
 INSTRUCCIONES DE MONTAJE - BAUANLEITUNG - INSTRUCCIONES DE MONTAJE

①



PARACOPPA
 OIL CARTER PROTECTION
 SABOT MOTEUR
 SPEZIFISCHER MOTORSCHUTZ
 CUBRE CARTER

Q.TY n.1

②



PIASTRINA
 LITTLE PLATE
 PETITE PLAQUE
 PLAETTCHEN
 PLAQUETA

GL2137

Q.TY n.1

③



PIASTRINA
 LITTLE PLATE
 PETITE PLAQUE
 PLAETTCHEN
 PLAQUETA

GL2139

Q.TY n.1

④



PIASTRINA CENTRALE
 CENTRAL LITTLE PLATE
 PETITE PLAQUE CENTRALE
 ZENTRUM PLAETTCHEN
 PLAQUETA CENTRAL

GL2138

Q.TY n.1

⑤



VITE TEF M6 x 16 mm
 SCREW
 VIS
 SCHRAUBE
 TORNILLO

Q.TY n.2

⑥



VITE TBEI M6 x 25 mm
 SCREW
 VIS
 SCHRAUBE
 TORNILLO

Q.TY n.2

⑦



VITE TE M10 x 120 mm
 SCREW M10 x 120 mm
 VIS M10 x 120 mm
 SCHRAUBE M10 x 120 mm
 TORNILLO M10 x 120 mm

Q.TY n.1

⑧



VITE TBEIFN M6 x 16
 SCREW
 VIS
 SCHRAUBE
 TORNILLO

Q.TY n.4

⑨



RONDELLA Ø6x18 nera
 WASHER Ø6x18 black
 RONDELLE Ø6x18 noire
 SCHEIBE Ø6x18 schwarz
 ARANDELA Ø6x18 negra

Q.TY n.2

⑩



RONDELLA Ø10 mm
 WASHER Ø10 mm
 RONDELLE Ø10 mm
 SCHEIBE Ø10 mm
 ARANDELA Ø10 mm

Q.TY n.2

⑪



RONDELLA ZIGRINATA Ø6
 WASHER Ø6
 RONDELLE Ø6
 SCHEIBE Ø6
 ARANDELA Ø6

Q.TY n.4

⑫



DADO A.B. M6
 FLANGIATO
 BOLT M6
 ECROU M6
 MUTTER M6
 TUERCA M6

Q.TY n.2

⑭



DADO A.B. M10
 BOLT M10
 ECROU M10
 MUTTER M10
 TUERCA M10

Q.TY n.1

⑬



DISTANZIALE Ø10 x 9.8 mm
 foro Ø8.2 mm
 SPACER
 ENTRETOISE
 DISTANZSTUECK
 DISTANCADOR

V044

Q.TY n.2

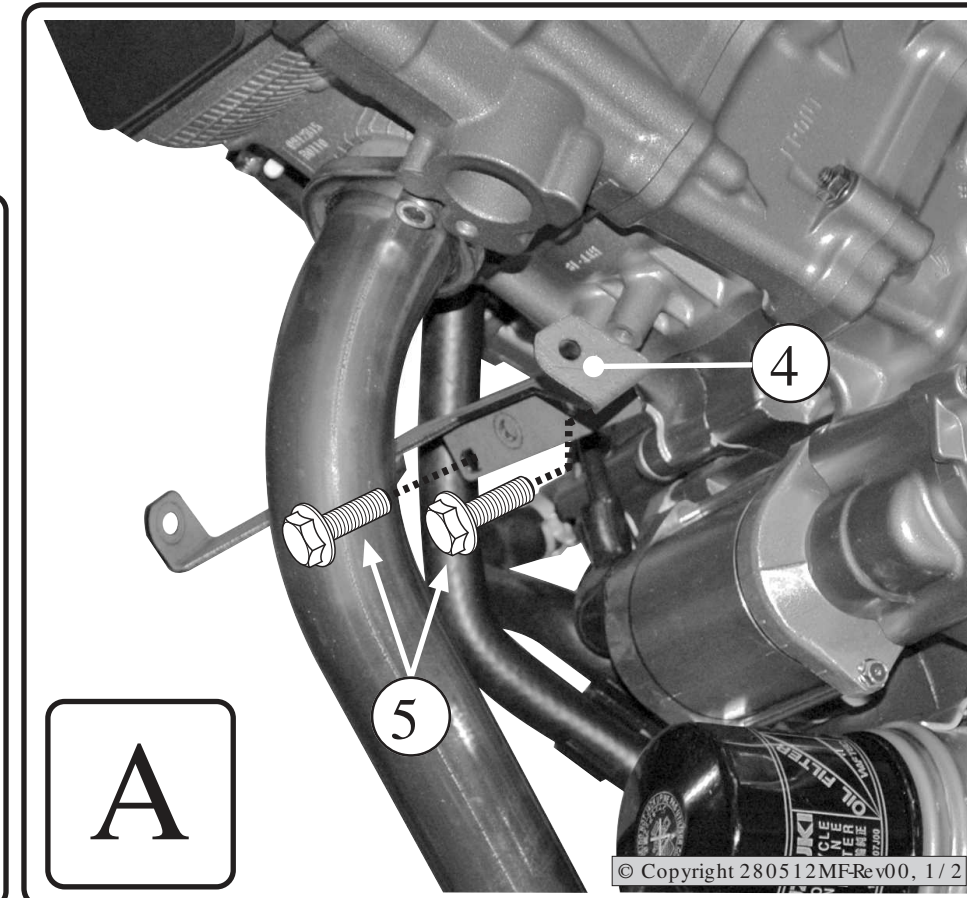
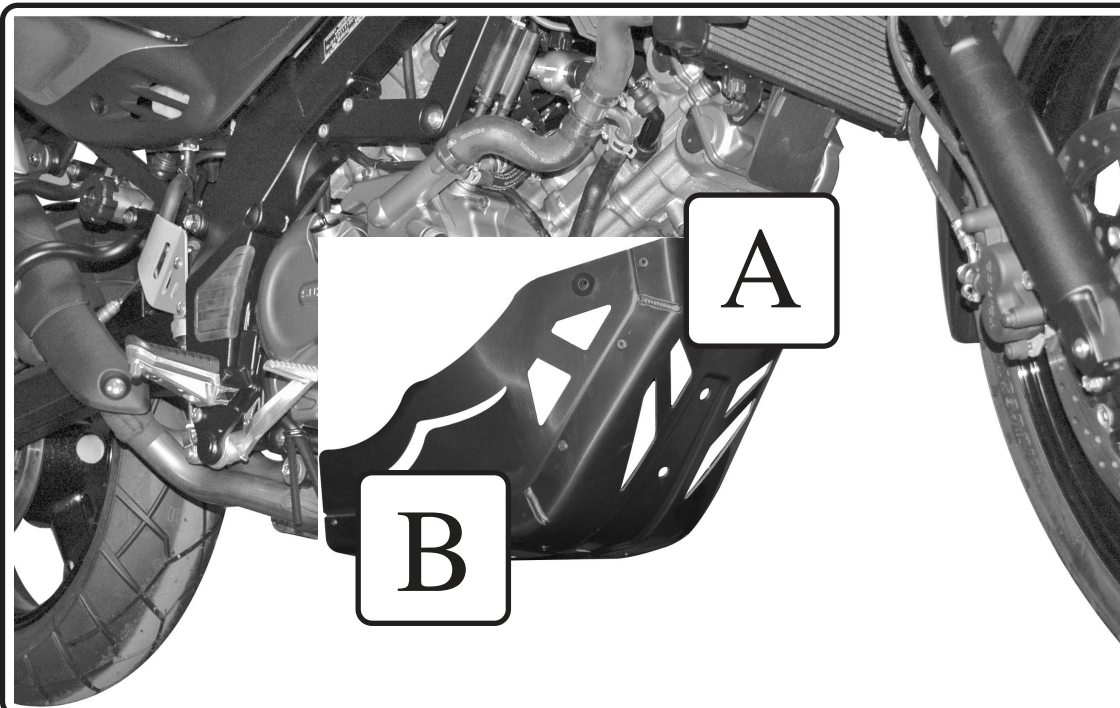

PARACOPPA SPECIFICO - OIL CARTER PROTECTION
 SABOT MOTEUR SPECIFIQUE - SPEZIFISCHER MOTORSCHULTZ - CUBRE CARTER ESPECIFICO

SUZUKI DL650 V-STROM L2

2011 - 2012

ISTRUZIONI DI MONTAGGIO - MOUNTING INSTRUCTIONS
 INSTRUCCIONES DE MONTAJE - BAUANLEITUNG - INSTRUCCIONES DE MONTAJE

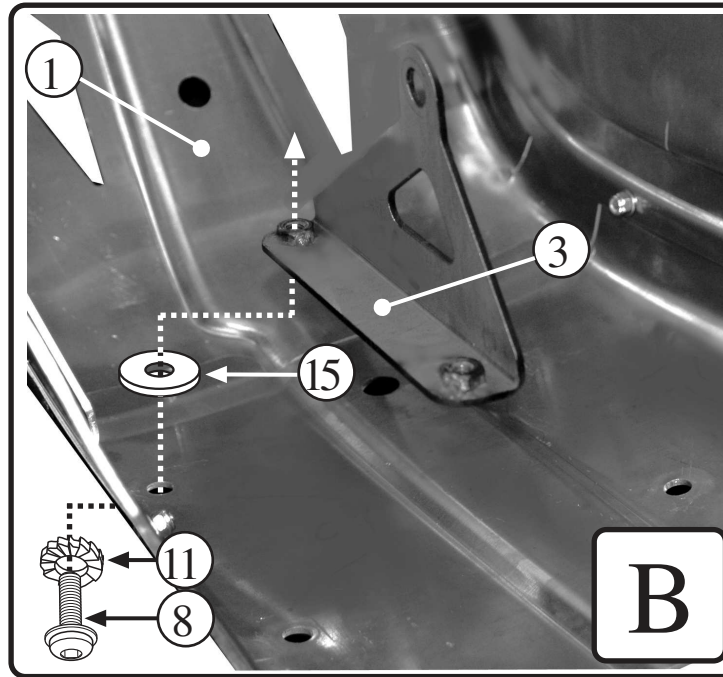

(15)
0-RONG

RONDELA IN GOMMA
 RUBBER WASHER
 RONDELE EN CAOUTCHOUC
 GUMMI SCHEIBE
 ARANDELA DE GOMA

Q. TY n.4

(16)
Z268

GOMMINO
 FAIRLEADER
 CHAUMARD
 GUMMI
 GOMA

Q. TY n.2

