

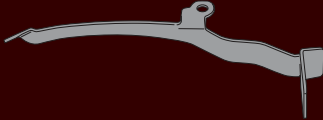









D2111KIT - D2111KIT

ATTACCHI SPECIFICI - SPECIFIC FITTING KIT FOR - KIT DE MONTAGE SPECIFIQUE POUR
 SPEZIFISCHER MONTAGEKIT FÜR - ANCLAJE ESPECÍFICO PARA - ANCHORAGE ESPECÍFICO

YAMAHA X-MAX 400 (2013)

N°	Descrizione	Caratteristiche	Codice	Quantità	
1	Supporto - Support - Support Halterung - Soporte - Apoio	Sp. 2,5mm	GL2464DX/SXGOM	2 (Dx/Sx)	
2	Vite - Screw Vis - Schraube Tornillo - Parafuso	TBEI M6x25	625TBEI	2	
3	Vite - Screw Vis - Schraube Tornillo - Parafuso	TBEI M5x35	535TBEI	2	
4	Rondella - Washer Rondelle - Scheibe Arandela - Arruela	Ø5	515RON	2	
5	Distanziale - Spacer Entretoise - Distanzstueck Distanciador - Españador	Ø16x18 Foro 6,5mm	C16L18F6,5T	2	
6	Dado - Bolt - Ecrou Mutter - Tuerca - Porca	Dado Auto Bloccante Flangiato M6	6DADIAFLN	2	
7	Clip - Clip - Agrafe Klammer - Presilla - Grampo	M5	Z2281	2	
8	Boccola Di Retenzione - Plastic Bush Doutille Plastique - Plastik Buchse Casquillo - Concha	-	Z871N	2	
9	Gommino - Fairleader Chaumard - Gummi Goma - Borracha	-	Z268	2	
10	-	-	-	1	
11	Componenti Originali- Original Parts Parties Originales - Original Bauteile Componentes Originales - Componentes Originais	-	-	-	-

D2111KIT - D2111KIT
ATTACCHI SPECIFICI - SPECIFIC FITTING KIT FOR - KIT DE MONTAGE SPECIFIQUE POUR
SPEZIFISCHER MONTAGEKIT FÜR - ANCLAJE ESPECÍFICO PARA - ANCHORAGE ESPECÍFICO
YAMAHA X-MAX 400 (2013)

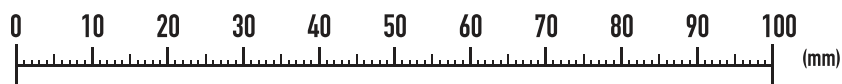
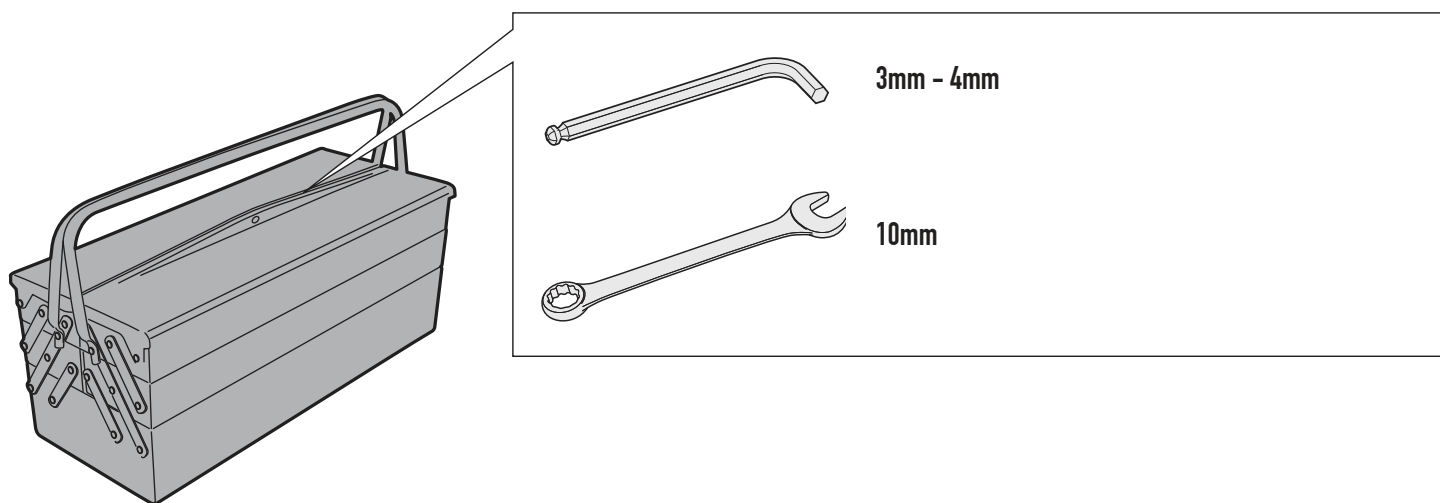

D2111KIT - D2111KIT

ATTACCHI SPECIFICI - SPECIFIC FITTING KIT FOR - KIT DE MONTAGE SPECIFIQUE POUR
SPEZIFISCHER MONTAGEKIT FÜR - ANCLAJE ESPECÍFICO PARA - ANCHORAGE ESPECÍFICO

YAMAHA X-MAX 400 (2013)

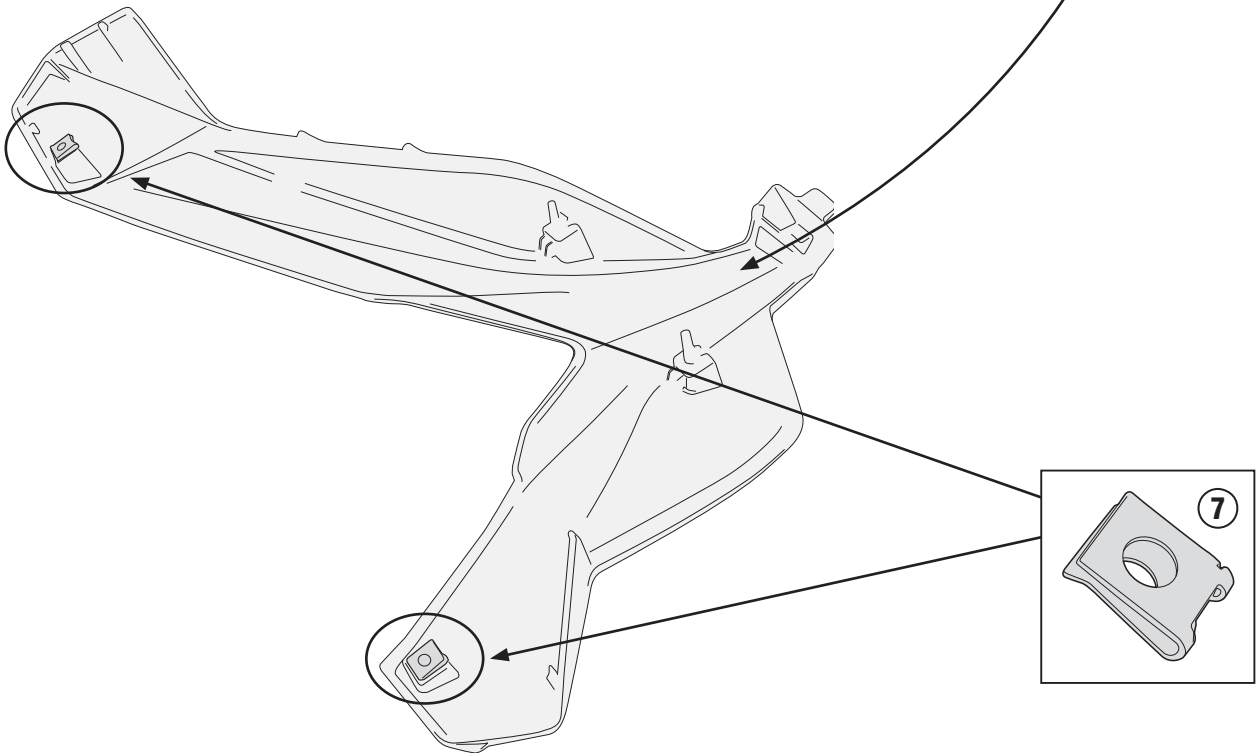
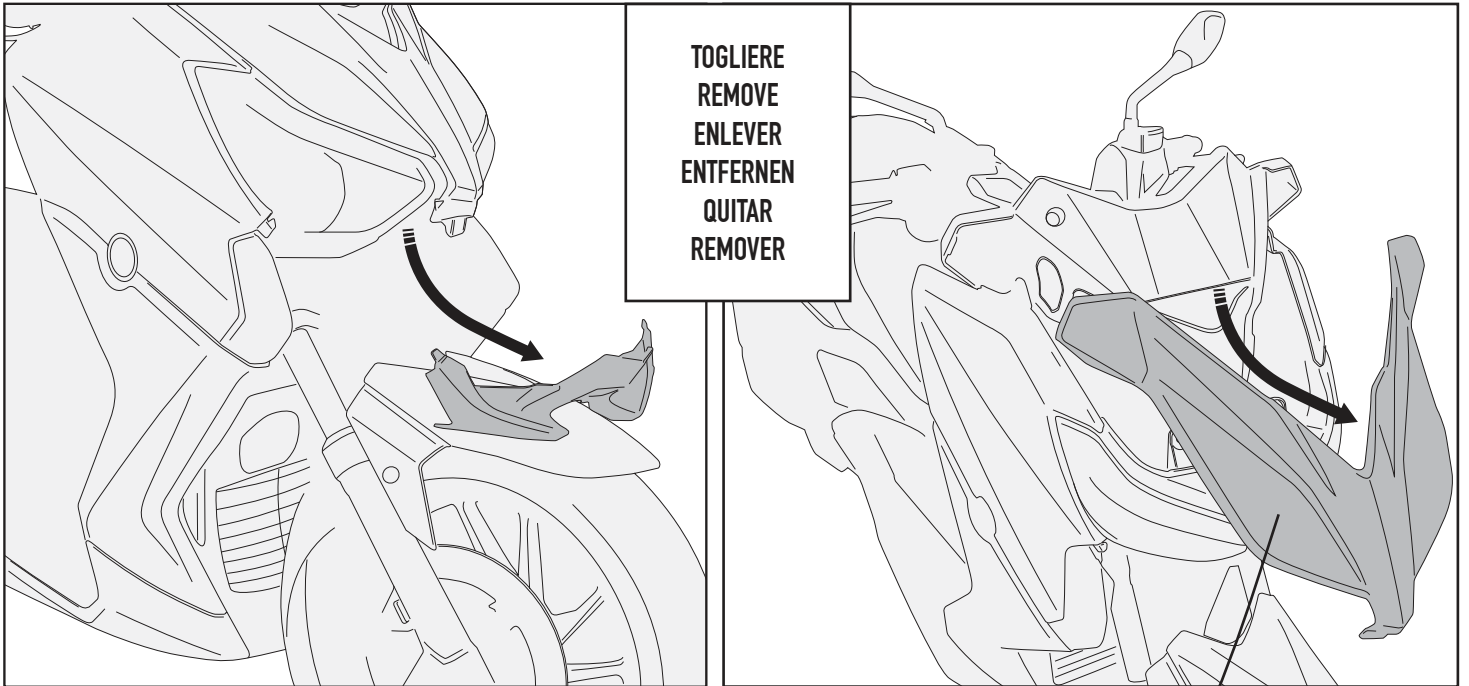

D2111KIT - D2111KIT

ATTACCHI SPECIFICI - SPECIFIC FITTING KIT FOR - KIT DE MONTAGE SPECIFIQUE POUR
 SPEZIFISCHER MONTAGEKIT FÜR - ANCLAJE ESPECÍFICO PARA - ANCHORAGE ESPECÍFICO

YAMAHA X-MAX 400 (2013)

